

HP 9250C Digital Sender User Guide

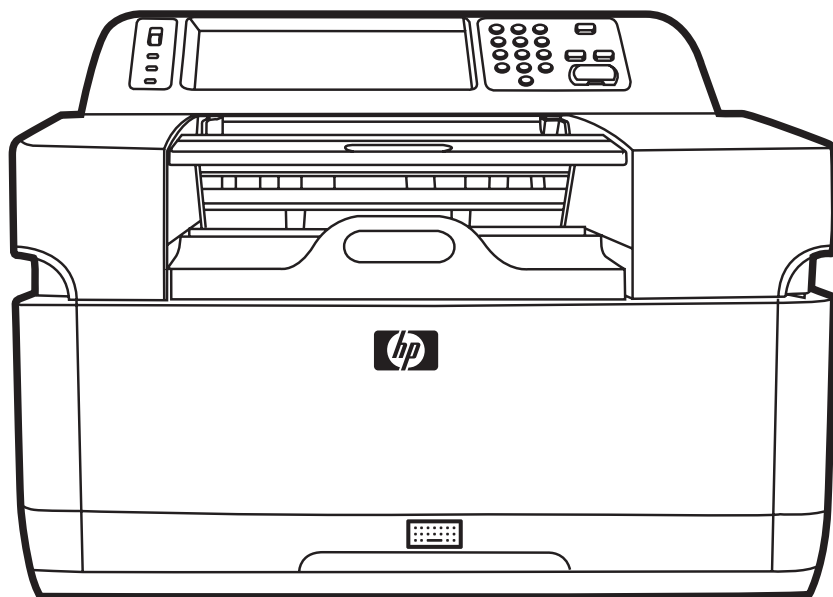

HP 9250C Digital Sender

User Guide



Copyright information

© 2007 Copyright Hewlett-Packard
Development Company, L.P.

Reproduction, adaptation, or translation
without prior written permission is prohibited,
except as allowed under the copyright laws.

The information contained herein is subject
to change without notice.

The only warranties for HP products and
services are set forth in the express warranty
statements accompanying such products
and services. Nothing herein should be
construed as constituting an additional
warranty. HP shall not be liable for technical
or editorial errors or omissions contained
herein.

Part number: CB472-90949

Edition 1, 6/2007

Trademark Credits

Linux is a U.S. registered trademark of Linus
Torvalds.

Microsoft®, Windows®, and Windows NT®
are U.S. registered trademarks of Microsoft
Corporation.

Table of contents

1 Device basics

Device information	2
Where to get more information	2
Features	3
Performance	4
ADF performance	4
Duty cycle	4
Device software	5
Digital-sender software	5
Network components used for digital-sending	6
Paper handling	7
Device parts	8
Space requirements	10

2 Control panel

Use the control panel	12
Control-panel layout	12
Home screen	13
Buttons on the touchscreen	14
Control-panel help system	14
Navigate the Administration menu	15
Information menu	15
Default Job Options menu	16
Default Options for Originals	16
Image Adjustment	16
Default E-mail Options	17
Default Send to Folder Options	18
Time/Scheduling menu	19
Management menu	20
Initial Setup menu	21
Networking and I/O	21
E-mail Setup	28
Send Setup menu	28
Device Behavior menu	29
Troubleshooting menu	30
Resets menu	30
Service menu	30

3 Connectivity

Novell NetWare support	32
Network configuration	33
Configure TCP/IPv4 parameters	33
Set an IP address	33
Set the subnet mask	34
Set the default gateway	34
Configure TCP/IPv6 parameters	35
HP Jetdirect EIO print servers	35

4 Use device features

Load media	38
Load media on the scanner glass	38
Load the automatic document feeder (ADF)	38
Use the keyboard	40
Basic send information	41
Log in	41
Change settings for the current job	41
Cancel send	42
Configure the device to send e-mail	43
Supported protocols	43
Configure e-mail server settings	43
Find gateways	44
Find the SMTP gateway from the device control panel	44
Find the SMTP gateway from an e-mail program	44
Send an e-mail	45
Use the Send E-mail screen	45
Send a document	45
Use the auto-complete function	46
Use the address book	46
Create a recipient list	46
Use the local address book	47
Add e-mail addresses to the local address book	47
Delete e-mail addresses from the local address book	47
Scan to a folder	48
Scan to a workflow destination	49
Send a digital fax	50

5 Manage and maintain the device

Use information pages	52
Use the embedded Web server	53
Open the embedded Web server by using a network connection	53
Embedded Web server sections	54
Use HP Web Jetadmin software	56
Controlling digital-sending security	57
Network authentication	57
Secure e-mail	57
Restrict software access	57
Security lock	57
Replace supplies and parts	58
Replace the mylar sheet	58

Replace the ADF Maintenance Kit	58
Clean the device	60
Clean the exterior	60
Clean the glass	60
Clean the touchscreen	60
Clean the ADF delivery system	60
Clean the ADF rollers	61
Upgrade the firmware	64
Determine the current level of firmware	64
Download new firmware from the HP Web site	64
Use FTP to upgrade the firmware on a direct network connection	64
Use a USB connection to upgrade the device firmware	66
Use HP Web Jetadmin to upgrade the firmware	66
Upgrade the HP Jetdirect Inside firmware	67
Calibrate the scanner	68

6 Problem solving

Sources for information about problems	70
Control-panel messages	71
Control-panel message types	71
Resolve control-panel messages	71
Jams	75
Avoid jams	75
Clear jams	75
Solve e-mail problems	77
Validate the e-mail server (SMTP gateway) address	77
Validate the LDAP gateway address	77

Appendix A Service and support

Hewlett-Packard limited warranty statement	79
Customer self repair warranty service	81
Hewlett-Packard limited warranty statement for software	82
Availability of support and service	83
HP maintenance agreements	84
Next-Day Onsite Service	84

Appendix B Specifications

Physical specifications	86
Electrical specifications	86
Power consumption specifications	86
Environmental specifications	87
Acoustic emissions	87

Appendix C Regulatory information

FCC regulations	90
Environmental Product Stewardship program	91
Protecting the environment	91
Ozone production	91
Power consumption	91

Plastics	91
Material restrictions	91
Disposal of waste equipment by users in private households in the European Union	92
Material Safety Data Sheet (MSDS)	92
For more information	92
Declaration of conformity	93
Country-/region-specific safety statements	94
Canadian DOC regulations	94
VCCI statement (Japan)	94
EMI statement (Korea)	94

Index	95
--------------------	-----------

1 Device basics

- [Device information](#)
- [Features](#)
- [Performance](#)
- [Device software](#)
- [Network components used for digital-sending](#)
- [Paper handling](#)
- [Device parts](#)
- [Space requirements](#)

Device information

The HP 9250C Digital Sender connects directly to your network converts black-and-white and color documents, drawings, and photographs into an electronic form and then distributes them directly to several kinds of destinations. You can also install the included HP Digital Sending Software (HP DSS) program to use advanced digital sending features such as send-to-workflow with optical character recognition (OCR).

Installing the device is simply a matter of connecting it to your network and configuring the digital-sending features. The digital sender operates as a standalone unit on the network and does not require network privileges for administration.

Where to get more information

The following table outlines the digital sending features that are available, and where to find more information about these features. All of the documentation listed in this table can be found on the documentation CD that came in the box with the device.

Feature	Description	For more information
Scan to E-mail	Scan a document and send it to any e-mail address.	User guide or DSS support guide
Scan to Folder	Scan a document to a network folder. More than one folder destination can be configured.	EWS user guide
Address Book for E-mail and Fax	Enter names and e-mail addresses or names and fax numbers for e-mail and fax recipients into the device's address book. This feature can also be used to manage the fax speed dials list.	User guide (EWS user guide for detailed information)
User PIN Authentication	Enter names and personal identification numbers (PIN) so that only authorized users can use specific features of the device.	EWS user guide
LDAP Addressing	Configure the device to search an LDAP (Lightweight Directory Access Protocol) directory for names and e-mail addresses. This feature makes the addressing of send to e-mail jobs easier.	EWS user guide or DSS support guide
LDAP Authentication	Configure the device to require user authentication to use specific device features. This feature relies on an existing LDAP infrastructure, and can be configured to support LDAP over a Secure Sockets Layer (SSL).	EWS user guide
Kerberos Authentication	Configure the device to require user authentication to use specific features of the device. This feature relies on an existing Kerberos Realm infrastructure. A Microsoft Windows Domain environment supports Kerberos natively.	EWS user guide
DSS LAN Fax	Use the device to route fax jobs via an existing LAN fax infrastructure.	DSS support guide

Feature	Description	For more information
DSS Send to Folder	Scan a document to a network folder. More than one folder destination can be configured.	DSS support guide
DSS Workflow	Scan a document and capture information about the scanned document by prompting the user. The document can then be routed to another application. This feature can be configured to use OCR (Optical Character Recognition).	DSS support guide
DSS Windows Negotiated Authentication	Configure the device to require user authentication to use specific features of the device. This feature relies on an existing Microsoft Windows domain infrastructure.	DSS support guide
DSS LDAP Authentication	Configure the device to require user authentication to use specific features of the device. This feature relies on an existing LDAP infrastructure.	DSS support guide

Features

The digital sender includes the following features:

- **Digital sending**—Send scanned files to e-mail addresses, fax destinations, and network folders. Advanced digital-sending functions are carried out by the HP Digital Sending Software (HP DSS), which is included with the device.
- **ADF**—The legal-size ADF accepts up to 50 pages, and includes built-in duplexing for scanning both sides of a double-sided document.
- **Interactive touchscreen control panel**—Intuitive onscreen menus and wizards help you to complete digital-sending tasks.
- **Flatbed scanner**—The letter/A4-size scanner can scan in both black-and-white and color, with the ability to scan up to 1 mm (0.04 inch) from the paper edge.
- **Memory**—The device comes standard with 256 megabytes (MB) of random access memory (RAM).
- **Hard disk**—The device includes a 40-gigabyte (GB) internal hard drive for storing documents and settings.
- **Connectivity**—The device provides a 10/100Base-T port, through Jetdirect Inside an HP Jetdirect Fast Ethernet port, and an enhanced input/output (EIO) expansion slot for connectivity.

Performance

The following sections give specific performance statistics for the digital sender.

ADF performance

The following table shows the images per minute (ipm) speed of the digital sender ADF.

Mode	Dots per inch (dpi)	Speed (ipm), A4	Speed (ipm), letter
Simplex mono mode	600 x 600	52	54
	600 x 300	53	55
Simplex color mode	600 x 600	29	31
	600 x 300	29	31
Duplex mono mode	600 x 600	24	25
	600 x 300	24	25
Duplex color mode	600 x 600	18	18
	600 x 300	18	18

Duty cycle

- The maximum duty cycle is 60,000 total images scanned per month.
- The monthly usage is 3,600 pages per month.

Device software

Digital-sender software

To take advantage of advanced digital-sender features such as scanning with OCR or sending to a workflow, you can install the HP Digital Sending Software Version 4 (HP DSS) that is provided on a CD-ROM with the device. This software runs as a service on a network server. It is not necessary to install any software or drivers on individual user's computers.

See the *HP Digital Sending Software Support Guide* on the documentation CD for software installation and configuration instructions.

The most recent software updates are available on the Internet at www.hp.com/support/dss.

Network components used for digital-sending

The following table describes the network components used for digital sending.

Component	Description
Network server running Windows® 2000 Professional, Server, or Advanced Server; Windows XP Professional; or Windows Server 2003 Standard or Enterprise Server	<p>The server contains the following components:</p> <ul style="list-style-type: none"> • HP DSS • HP MFP DSS Configuration Utility—used to configure and monitor digital-sending features after the HP DSS program has been installed • Windows 2000 Fax service—required only when the Windows 2000 Fax service is the method of fax transport
Network	Fast Ethernet 100Base-TX or Ethernet 10Base-T
Digital senders or HP multi-function peripheral (MFP) devices	<p>An HP DSS server can support up to 1000 HP 9250C Digital Senders, HP 9200C Digital Senders, or MFP devices on the same network. Each device can be individually configured to support any or all of the digital-sending options.</p> <p> NOTE: HP DSS does not support the HP 9100C or 8100C Digital Senders.</p>
Web browser	Users can use a Web browser from any computer on the network to configure and monitor the digital sender by using HP Web Jetadmin, or the digital sender's embedded Web server.
SMTP-enabled e-mail server	This gateway facilitates the e-mail and Internet fax digital-sending options.
LAN fax server (requires DSS)	A LAN fax server is a network device that centrally handles the sending and receiving of large numbers of fax jobs. HP DSS can be used to configure the digital sender to route outgoing faxes to a LAN fax server.
LDAP server	An LDAP server is a directory server that contains recipients' names and e-mail addresses and supports Lightweight Directory Access Protocol (LDAP). HP DSS uses the LDAP server to obtain addresses for the digital-sender address book.
FTP server	A file transfer protocol (FTP) server can be used as a destination for documents scanned by the digital sender.
Domain controller/Novell directory server (requires DSS)	In order to support user authentication, the digital sender must have access to a domain controller or Novell directory server in order to validate the user's login information.
Network printer (requires DSS)	A network printer can be set up as a destination for documents scanned by the digital sender.
Kerberos Domain Controller	A Kerberos Domain Controller (KDC) provides Kerberos Authentication services on the network. A Windows Domain Controller can be configured to act as a Kerberos Domain Controller.
Novell Network Support (requires DSS)	If Novell file servers are used on the network, HP DSS can write files into network folders and support network fax folders that reside on Novell servers. The Novell client software must be installed on the network and be configured correctly before Novell-specific attributes can be configured in HP DSS.

Paper handling

The HP 9250C Digital Sender supports the following standard paper sizes:

- **Letter:** 215.9 x 279 mm (8.5 x 11 inches)
- **Executive:** 190 x 254 mm (7.5 x 10 inches)
- **A4:** 210 x 297 mm (8.3 x 11.7 inches)
- **A5:** 148 x 210 mm (5.83 x 8.27 inches)
- **B5:** 176 x 250 mm (6.9 x 9.8 inches)
- **Legal (from the ADF only):** 215.9 x 355.6 mm (8.5 x 14 inches)

Paper weight: 60 to 120 g/m² (16 to 32 lb)

Up to 50 sheets of paper can be stacked in the ADF, with a maximum height of 5 mm (0.2 inch).

Device parts

Before using the digital sender, familiarize yourself with its parts.

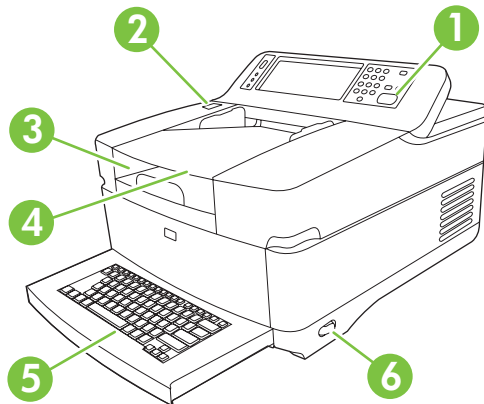

1	Control panel
2	Jam release button
3	Output bin
4	ADF input bin
5	External Qwerty keyboard (pull to open)
6	On/off switch

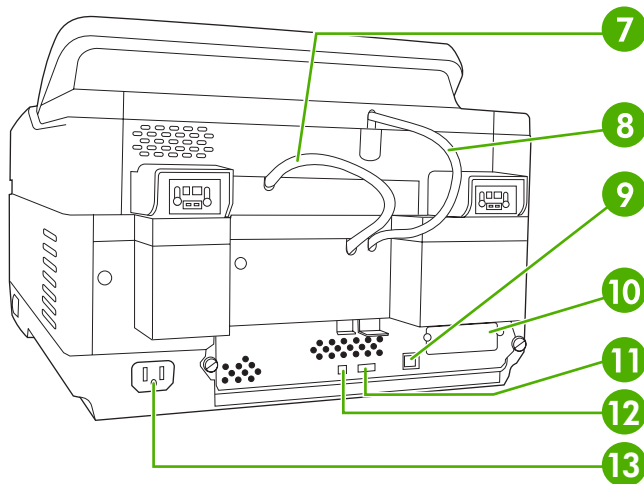

7	ADF cable
8	Control-panel cable
9	10/100Base-T network port
10	EIO slot
11	USB host port
12	Power input port
13	Power input port

12	USB device port
13	Power connector

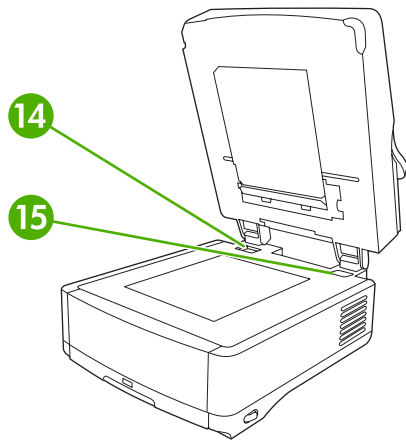

14	Scanner lock
15	Serial number

Space requirements

The following figures illustrate the space requirements for the HP 9250C Digital Sender.

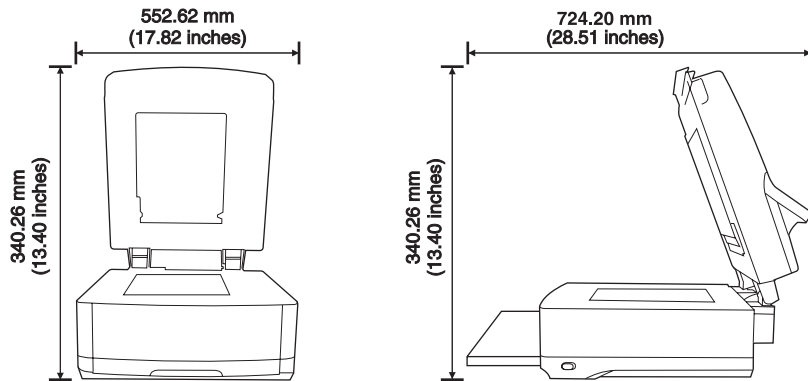

NOTE: The digital sender requires 90 mm (3.5 inches) of free space behind the device in order to fully open the top.

2 Control panel

- [Use the control panel](#)
- [Navigate the Administration menu](#)
- [Information menu](#)
- [Default Job Options menu](#)
- [Time/Scheduling menu](#)
- [Management menu](#)
- [Initial Setup menu](#)
- [Device Behavior menu](#)
- [Troubleshooting menu](#)
- [Resets menu](#)
- [Service menu](#)

Use the control panel

The control panel has a VGA touchscreen that provides access to all device functions. Use the buttons and numeric keypad to control jobs and the device status. The LEDs indicate overall device status.

Control-panel layout

The control panel includes a touchscreen graphical display, job-control buttons, a numeric keypad, and three light-emitting diode (LED) status lights.

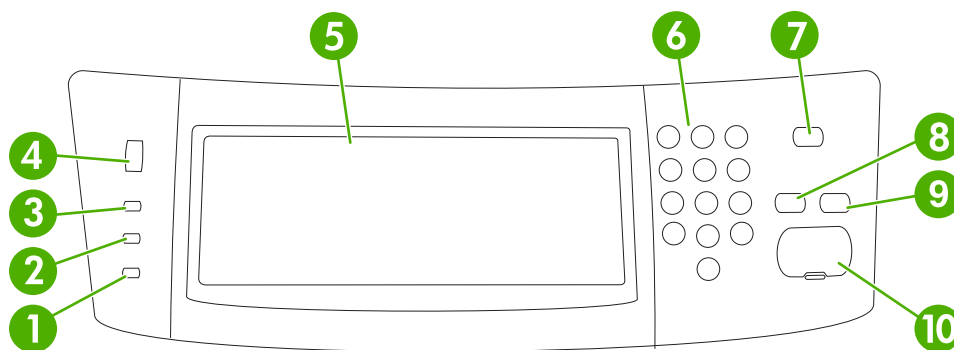

1	Attention light	The Attention light indicates that the device has a condition that requires intervention, such as an error message on the touchscreen.
2	Data light	The Data light indicates that the device is receiving data.
3	Ready light	The Ready light indicates that the device is ready to begin processing a job.
4	Brightness-adjustment dial	Turn the dial to control the brightness of the touchscreen.
5	Touchscreen graphical display	Use the touchscreen to open and set up all device functions.
6	Numeric keypad	Use the keypad to type numeric values, such as a fax number.
7	Sleep button and light	If the device is inactive for a long period of time, it automatically enters Sleep mode. To place the device into Sleep mode or to reactivate the device, press the Sleep button. When the light is glowing, the device is in Sleep mode.
8	Reset button	Resets the job settings to factory or user-defined default values.
9	Stop button	Stops the active job. While stopped, the control panel shows the options for the stopped job (for example, if you press Stop while the device is processing an e-mail job, the control panel message prompts you to cancel or resume the job).
10	Start button and light	Starts digital sending, or resumes a job that has been interrupted. When the light is glowing, the device is ready to start scanning.

Home screen

The home screen provides access to the device features, and it indicates the current status of the device.





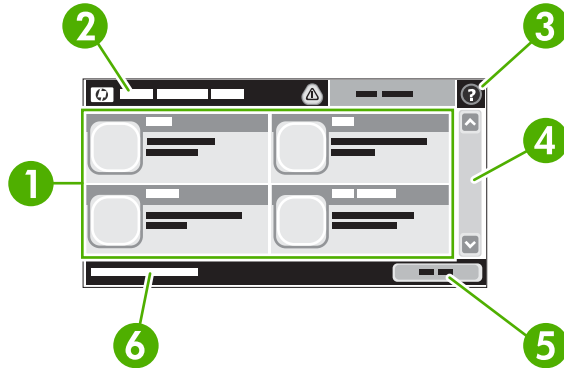



NOTE: Depending on how the system administrator has configured the device, the features that appear on the home screen can vary.



1	Features	Depending on how the system administrator has configured the device, the features that appear in this area can include any of the following items: <ul style="list-style-type: none">• Fax• E-mail• Secondary E-mail• Network Folder• Supplies Status• Administration
2	Device status line	The status line provides information about the overall device status. Various buttons appear in this area, depending on the current status. For a description of each button that can appear in the status line, see Buttons on the touchscreen on page 14 .
3	Help button	Touch the Help button to open the embedded help system.
4	Scroll bar	Touch the up or down arrows on the scroll bar to see the complete list of available features.
5	Network Address button	Touch Network Address to find information about the network connection.
6	Date and time	The current date and time appear here. The system administrator can select the format that the device uses to show the date and time, for example 12-hour format or 24-hour format.

Buttons on the touchscreen

The status line on the touchscreen provides information about the status of the device. Various buttons can appear in this area. The following table describes each button.

	Home button. Touch the home button to go to the Home screen from any other screen.
	Start button. Touch the Start button to begin the action for the feature that you are using.
	Stop button. If the device is processing a fax job, the Stop button appears instead of the Start button. Touch the Stop button to halt the current job. The device prompts you to cancel the job or to resume it.
	Error button. The error button appears whenever the device has an error that requires attention before it can continue. Touch the error button to see a message that describes the error. The message also has instructions for solving the problem.
	Warning button. The warning button appears when the device has a problem but can continue functioning. Touch the warning button to see a message that describes the problem. The message also has instructions for solving the problem.
	Help button. Touch the help button to open the built-in online Help system. For more information, see Control-panel help system on page 14 .

Control-panel help system

The device has a built-in Help system that explains how to use each screen. To open the Help system, touch the Help button (🔍) in the upper-right corner of the screen.

For some screens, the Help opens to a global menu where you can search for specific topics. You can browse through the menu structure by touching the buttons in the menu.

For screens that contain settings for individual jobs, the Help opens to a topic that explains the options for that screen.

If the device alerts you of an error or warning, touch the error (❗) or warning (⚠️) button to open a message that describes the problem. The message also contains instructions to help solve the problem.

Navigate the Administration menu

From the Home screen, touch **Administration** to open the menu structure. You might need to scroll to the bottom of the Home screen to see this feature.

The Administration menu has several sub-menus, which are listed on the left side of the screen. Touch the name of a menu to expand the structure. A plus sign (+) next to a menu name means that it contains sub-menus. Continue opening the structure until you reach the option that you want to configure. To return to the previous level, touch **Back**.

To exit the Administration menu, touch the Home button (🏠) in the upper-left corner of the screen.

The device has built-in Help that explains each of the features that are available through the menus. Help is available for many menus on the right-hand side of the touchscreen. Or, to open the global Help system, touch the Help button (?) in the upper-right corner of the screen.

The tables in the sections that follow indicate the overall structure of each menu.

Information menu

Use this menu to view information pages that are stored internally on the device.

Table 2-1 Information menu

Menu item	Sub-menu item	Values	Description
Configuration/Status Pages	Configuration Page	Show (button)	Configuration pages that show the current device settings.
	Usage Page	OK (button)	Shows information about the number of pages that have been scanned on each paper type and size.

Default Job Options menu

Use this menu to define the default job options for each function. If the user does not specify the job options when creating the job, the default options are used.

The **Default Job Options** menu contains the following sub-menus:

- Default Options for Originals
- Image Adjustment
- Default E-mail Options
- Default Send to Folder Options

Default Options for Originals

Menu item	Values	Description
Paper Size	Select a paper size from the list.	Select the paper size that is most often used for copy or scan originals.
Number of Sides	1 2	Select whether copy or scan originals are most often single-sided or double-sided.
Orientation	Portrait Landscape	Select the orientation that is most often used to scan originals. Select Portrait if the short edge is at the top or select Landscape if the long edge is at the top.
Optimize Text/Picture	Manually Adjust Text Photograph	Use this setting to optimize the output for a particular type of original. You can optimize the output for text, pictures, or a mixture. If you select Manually Adjust , you can specify the mix of text and pictures that will most often be used.

Image Adjustment

Menu item	Values	Description
Darkness	Adjust the value within the range.	Use the setting to adjust the lightness or darkness of the output.
Background Cleanup	Adjust the value within the range.	Increase the Background Cleanup setting to remove faint images from the background or to remove a light background color.
Sharpness	Adjust the value within the range.	Adjust the Sharpness setting to clarify or soften the image.

Default E-mail Options

Use this menu to set default options for e-mails that are sent from the device.

Menu item	Values	Description
Document File Type	PDF (default)	Choose the file format for the e-mail.
	JPEG	
	TIFF	
	M-TIFF	
Output Quality	High (large file)	Choosing higher quality for output increases the size of the output file.
	Medium (default)	
	Low (small file)	
Resolution	75 DPI	Use this feature to select the resolution. Use a lower setting to create smaller files.
	150 DPI (default)	
	200 DPI	
	300 DPI	
Color/Black	Color scan (default)	Specify whether the e-mail will be in black or in color.
	Black/white scan	
TIFF Version	TIFF 6.0 (default)	Use this feature to specify the TIFF version to use when saving scanned files.
	TIFF (Post 6.0)	

Default Send to Folder Options

Use this menu to set default options for scan jobs sent to the computer.

Menu item	Values	Description
Color/Black	Color scan	Specify whether the file will be in black or in color.
	Black/white scan (default)	
Document File Type	PDF (default)	Choose the file format for the file.
	M-TIFF	
	TIFF	
	JPEG	
TIFF version	TIFF 6.0 (default)	Use this feature to specify the TIFF version to use when saving scanned files.
	TIFF (post 6.0)	
Output Quality	High (large file)	Choosing higher quality for output increases the size of the output file.
	Medium (default)	
	Low (small file)	
Resolution	75 DPI	Use this feature to select the resolution. Use a lower setting to create smaller files.
	150 DPI (default)	
	200 DPI	
	300 DPI	
	400 DPI	
	600 DPI	

Time/Scheduling menu

Use this menu to set options for setting the time and for setting the device to enter and exit Sleep mode.



NOTE: Values shown with "(default)" are the factory-default values. Some menu items have no default.

Menu item	Sub-menu item	Sub-menu item	Values	Description	
Date/Time	Date Format		YYYY/MMM/DD (default)	Use this feature to set the current date and time, and to set the date format and time format that are used to time-stamp outgoing faxes.	
			MMM/DD/YYYY		
			DD/MMM/YYYY		
	Date	Month			
		Day			
		Year			
	Time Format		12 hour (AM/PM) (default)		
			24 hour		
	Time	Hour			
		Minute			
AM					
PM					
Sleep Delay			1 minute	Use this feature to select the time interval that the device should remain inactive before entering Sleep mode.	
			20 minutes		
			30 minutes (default)		
			45 minutes		
			1 hour (60 minutes)		
			90 minutes		
			2 hours		
Wake Time	Monday		Off (default)	Select Custom to set a wake time for each day of the week. The device exits sleep mode according to this schedule. Using a sleep schedule helps conserve energy and prepares the device for use so that users do not have to wait for it to warm up.	
	Tuesday		Custom		
	Wednesday				
	Thursday				
	Friday				
	Saturday				
	Sunday				

Management menu

Use this menu to set up global device-management options.



NOTE: Values shown with "(default)" are the factory-default values. Some menu items have no default.

Table 2-2 Management menu

Menu item	Values	Description
Sleep mode	Disable	Use this feature to customize the Sleep mode settings for this device.
	Use Sleep Delay (default)	Select Use Sleep Delay to set the device to enter Sleep mode after the delay that is specified in the Time/Scheduling menu.

Initial Setup menu

The **Initial Setup** menu contains the sub-menus shown:

- **Networking and I/O** menu
- **E-mail Setup** menu
- **Send Setup** menu



NOTE: Values shown with "(default)" are the factory-default values. Some menu items have no default.

Networking and I/O

Menu item	Sub-menu item	Values	Description
I/O Timeout		Select a value in the range. The factory default setting is 15 seconds.	I/O timeout refers to the elapsed time before a job fails. If the stream of data that the device receives for a job gets interrupted, this setting indicates how long the device will wait before it reports that the job has failed.
Embedded Jetdirect	See Table 2-3 Jetdirect sub-menus on page 21 for the list of options.		
EIO <X> Jetdirect			

Table 2-3 Jetdirect sub-menus

Menu item	Sub-menu item	Sub-menu item	Values and Description
TCP/IP	Enable		Off: Disable the TCP/IP protocol.
			On (default): Enable the TCP/IP protocol.
	Host Name		An alphanumeric string, up to 32 characters, used to identify the device. This name is listed on the HP Jetdirect configuration page. The default host name is NPIxxxxxx, where xxxxxx is the last six digits of the LAN hardware (MAC) address.
	IPv4 Settings	Config Method	Specifies the method that TCP/IPv4 parameters will be configured on the HP Jetdirect print server. Bootp: Use BootP (Bootstrap Protocol) for automatic configuration from a BootP server. DHCP: Use DHCP (Dynamic Host Configuration Protocol) for automatic configuration from a DHCPv4 server. If selected and a DHCP lease exists, DHCP Release and DHCP Renew menus are available to set DHCP lease options. Auto IP: Use automatic link-local IPv4 addressing. An address in the form 169.254.x.x is assigned automatically. Manual: Use the Manual Settings menu to configure TCP/IPv4 parameters, such as an IPv4 address like 123.123.123.123.

Table 2-3 Jetdirect sub-menus (continued)

Menu item	Sub-menu item	Sub-menu item	Values and Description
		DHCP Release	<p>This menu appears if Config Method was set to DHCP and a DHCP lease for the print server exists.</p> <p>No (default): The current DHCP lease is saved.</p> <p>Yes: The current DHCP lease and the leased IP address are released.</p>
		DHCP Renew	<p>This menu appears if Config Method was set to DHCP and a DHCP lease for the print server exists.</p> <p>No (default): The print server does not request to renew the DHCP lease.</p> <p>Yes: The print server requests to renew the current DHCP lease.</p>
		Manual Settings	<p>(Available only if Config Method is set to Manual) Configure parameters directly from the device control panel:</p> <p>IP Address: The unique IP address of the device (n.n.n.n), where n is a value from 0 to 255.</p> <p>Subnet Mask: The subnet mask for the device (m.m.m.m), where m is a value from 0 to 255.</p> <p>Syslog Server: The IP address of the syslog server used to receive and log syslog messages.</p> <p>Default Gateway: The IP address of the gateway or router used for communications with other networks.</p> <p>Idle Timeout: The time period, in seconds, after which an idle TCP print data connection is closed (default is 270 seconds, 0 disables the timeout).</p>
		Default IP	<p>Specify the IP address to default to when the print server is unable to obtain an IP address from the network during a forced TCP/IP reconfiguration (for example, when manually configured to use BootP or DHCP).</p> <p>Auto IP: A link-local IP address 169.254.x.x is set.</p> <p>Legacy: The address 192.0.0.192 is set, consistent with older HP Jetdirect devices.</p>
		Primary DNS	Specify the IP address (n.n.n.n) of a Primary DNS Server.
		Secondary DNS	Specify the IP address (n.n.n.n) of a Secondary Domain Name System (DNS) Server.
	IPv6 Settings	Enable	<p>Use this item to enable or disable IPv6 operation on the print server.</p> <p>Off (default): IPv6 is disabled.</p> <p>On: IPv6 is enabled.</p>
		Address	Use this item to manually configure an IPv6 address.

Table 2-3 Jetdirect sub-menus (continued)

Menu item	Sub-menu item	Sub-menu item	Values and Description
			<p>Manual Settings: Use the Manual Settings menu to enable and manually configure a TCP/ IPv6 address in the format of 123.123.123.123.</p>
		DHCPV6 Policy	<p>Router Specified: The stateful auto-configuration method to be used by the print server is determined by a router. The router specifies whether the print server obtains its address, its configuration information, or both from a DHCPv6 server.</p> <p>Router Unavailable: If a router is not available, the print server should attempt to obtain its stateful configuration from a DHCPv6 server.</p> <p>Always: Whether or not a router is available, the print server always attempts to obtain its stateful configuration from a DHCPv6 server.</p>
		Primary DNS	Use this item to specify an IPv6 address for a primary DNS server that the print server should use.
		Manual Settings	<p>Use this item to manually set IPv6 addresses on the print server.</p> <p>Enable: Select this item and choose On to enable manual configuration, or Off to disable manual configuration.</p> <p>Address: Use this item to type a 32-hexadecimal digit IPv6 node address that uses the colon hexadecimal syntax.</p>
	Proxy Server		<p>Specifies the proxy server to be used by embedded applications in the device. A proxy server is typically used by network clients for Internet access. It caches Web pages, and provides a degree of Internet security, for those clients.</p> <p>To specify a proxy server, enter its IPv4 address or fully qualified domain name. The name can be up to 255 octets.</p> <p>For some networks, you might need to contact your internet service provider (ISP) for the proxy server address.</p>
		Proxy Port	Type the port number used by the proxy server for client support. The port number identifies the port reserved for proxy activity on your network, and can be a value from 0 to 65535.
Diagnostics	Embedded Test		<p>This menu provides tests to help diagnose network hardware or TCP/IP network connection problems.</p> <p>Embedded tests help to identify whether a network fault is internal or external to the device. Use an embedded test to check hardware and communication paths on the print server. After you select and enable a test and set the execution time, you must select Execute to initiate the test.</p> <p>Depending on the execution time, a selected test runs continuously until either the device is turned off, or an error occurs and a diagnostic page appears.</p>

Table 2-3 Jetdirect sub-menus (continued)

Menu item	Sub-menu item	Sub-menu item	Values and Description
		LAN HW Test	 <p>CAUTION: Running this embedded test will erase your TCP/IP configuration.</p> <p>This test performs an internal loopback test. An internal loopback test will send and receive packets only on the internal network hardware. There are no external transmissions on your network.</p> <p>Select Yes to choose this test, or No to not choose it.</p>
		HTTP Test	<p>This test checks operation of HTTP by retrieving predefined pages from the device, and tests the embedded Web server.</p> <p>Select Yes to choose this test, or No to not choose it.</p>
		SNMP Test	<p>This test checks operation of SNMP communications by accessing predefined SNMP objects on the device.</p> <p>Select Yes to choose this test, or No to not choose it.</p>
		Select All Tests	<p>Use this item to select all available embedded tests.</p> <p>Select Yes to choose all tests. Select No to select individual tests.</p>
		Data Path Test	<p>This test helps to identify data path and corruption problems on an HP postscript level 3 emulation device. It sends a predefined PS file to the device.</p> <p>Select Yes to choose this test, or No to not choose it.</p>
		Execution Time [H]	<p>Use this item to specify the length of time (in hours) that an embedded test will be run. You can select a value from 1 to 60 hours. If you select zero (0), the test runs indefinitely until an error occurs or device is turned off.</p>
		Execute	<p>No*: Do not initiate the selected tests.</p> <p>Yes: Initiate the selected tests.</p>

Table 2-3 Jetdirect sub-menus (continued)

Menu item	Sub-menu item	Sub-menu item	Values and Description
	Ping Test		This test is used to check network communications. This test sends link-level packets to a remote network host, then waits for an appropriate response. To run a ping test, set the following items:
		Dest Type	Specify whether the target device is an IPv4 or IPv6 node.
		Dest IP	IPV4: Type the IPv4 address. IPV6: Type the IPv6 address.
		Packet Size	Specify the size of each packet, in bytes, to be sent to the remote host. The minimum is 64 (default) and the maximum is 2048.
		Timeout	Specify the length of time, in seconds, to wait for a response from the remote host. The default is 1 and the maximum is 100.
		Count	Specify the number of ping test packets to send for this test. Select a value from 1 to 100. To configure the test to run continuously, select 0.
		Show Results	If the ping test was not set for continuous operation, you can choose to display the test results. Select Yes to show results. If you select No (default), results are not shown.
		Execute	Specify whether to initiate the ping test. Select Yes to initiate the test, or No to not run the test.

Table 2-3 Jetdirect sub-menus (continued)

Menu item	Sub-menu item	Sub-menu item	Values and Description
	Ping Results		Use this item to view the ping test status and results using the control panel display. You can select the following items:
		Packets Sent	Shows the number of packets (0 - 65535) sent to the remote host since the most recent test was initiated or completed.
		Packets Received	Shows the number of packets (0 - 65535) received from the remote host since the most recent test was initiated or completed.
		Percent Lost	Shows the percent of ping test packets that were sent with no response from the remote host since the most recent test was initiated or completed.
		RTT Min	Shows the minimum detected roundtrip- time (RTT), from 0 to 4096 milliseconds, for packet transmission and response.
		RTT Max	Shows the maximum detected roundtrip- time (RTT), from 0 to 4096 milliseconds, for packet transmission and response.
		RTT Average	Shows the average round-trip-time (RTT), from 0 to 4096 milliseconds, for packet transmission and response.
		Ping In Progress	Shows whether a ping test is in progress. Yes indicates a test in progress, and No indicates that a test completed or was not run.
		Refresh	When viewing the ping test results, this item updates the ping test data with current results. Select Yes to update the data, or No to maintain the existing data. However, a refresh automatically occurs when the menu times out or you manually return to the main menu.
Link Speed			<p>The link speed and communication mode of the print server must match the network. The available settings depend on the device and installed print server. Select one of the following link configuration settings:</p> <p> CAUTION: If you change the link setting, network communications with the print server and network device might be lost.</p> <p>Auto (default): The print server uses auto-negotiation to configure itself with the highest link speed and communication mode allowed. If auto-negotiation fails, either 100TX HALF or 10TX HALF is set depending on the detected link speed of the hub/switch port. (A 1000T half-duplex selection is not supported.)</p> <p>10T Half: 10 Mbps, half-duplex operation.</p> <p>10T Full: 10 Mbps, Full-duplex operation.</p> <p>100TX Half: 100 Mbps, half-duplex operation.</p> <p>100TX Full: 100 Mbps, full-duplex operation.</p>

Table 2-3 Jetdirect sub-menus (continued)

Menu item	Sub-menu item	Sub-menu item	Values and Description
			100TX Auto: Limits auto-negotiation to a maximum link speed of 100 Mbps.
			1000TX Full: 1000 Mbps, full-duplex operation.

E-mail Setup

Use this menu to enable the e-mail feature and to configure basic e-mail settings.



NOTE: To configure advanced e-mail settings, use the embedded Web server. For more information, see the embedded Web server guide on the device CD.

Menu item	Values	Description
Address Validation	On (default) Off	This option enables the device to check e-mail syntax when you type an e-mail address. Valid e-mail addresses require the "@" sign and a ".".
Find Send Gateways		Search the network for SMTP gateways that the device can use to send e-mail.
SMTP Gateway	Enter a value.	Specify the IP address of the e-mail server (SMTP gateway) that is used to send e-mail from the device.
Test Send Gateway		Test the configured SMTP gateway to see if it is functional.

Send Setup menu

Menu item	Values	Description
Replicate MFP	Enter a value (IP Address).	Copy the local Send settings from one device to another.
Allow Transfer to New DSS	Off On	Use this feature to allow the transfer of the device from one HP Digital Sending Software (DSS) server to another. HP DSS is a software package that handles digital sending tasks such as faxing, e-mail, and sending a scanned document to a network folder.
Allow Use of Digital Send Service	Off On	This feature allows you to configure the device for use with an HP Digital Sending Software (DSS) server.

Device Behavior menu



NOTE: Values shown with "(default)" are the factory-default values. Some menu items have no default.

Menu item	Sub-menu item	Values	Description
Language		Select the language from the list.	Use this feature to select a different language for control-panel messages. When you select a new language, the keyboard layout might also change.
Keyboard Layout		Select the keyboard configuration from the list.	Use this feature to select a different layout for the keyboard.
Key Press Sound		On (default) Off	Use this feature to specify whether you hear a sound when you touch the screen or press buttons on the control panel.
Inactivity Timeout		Type a value between 10 and 300 seconds. The factory default is 60 seconds.	Use this feature to specify the amount of time that elapses between any activity on the control panel and the device resetting to the default settings.
Warning/Error Behavior	Clearable Warnings	On Job (default)	Use this feature to set the amount of time that a clearable warning appears on the control panel.
	Continuable Events	Auto continue (10 seconds) (default) Touch OK to continue	Use this option to configure the device behavior when the device encounters certain errors.

Troubleshooting menu



NOTE: Values shown with "(default)" are the factory-default values. Some menu items have no default.

Menu item	Sub-menu item	Values	Description
Event Log		Show (button)	Use this features to view such device events as errors or a calibration.
Calibrate Scanner		Calibrate (button)	Use this feature to compensate for offsets in the scanner imaging system (carriage head) for ADF and flatbed scans. You might need to calibrate the scanner if it is not capturing the correct sections of scanned documents.
Scanner Tests	Lower Lamp Sensors ADF Input Motor ADF Input Reverse Flatbed Motor ADF Read Motor Reverse ADF Duplex Solenoid ADF LED Indicator		Service technicians should use this sub-menu to diagnose potential problems with the device scanner.
Control Panel	LEDs Display Buttons Touchscreen		Use this feature to make sure the components of the control panel are functioning correctly.

Resets menu

Menu item	Values	Description
Clear Local Address Book	Clear (button)	Use this feature to clear all addresses from the address books that are stored on the device.
Restore Factory Settings	Restore (button)	Use this feature to restore all device settings to their factory defaults.
Reset Supplies	New Document Feeder Kit (Yes/No)	Use this feature to notify the device that a new document feeder kit has been installed.

Service menu

The Service menu is locked and requires a PIN for access. This menu is intended for use by authorized service personnel.

3 Connectivity

- [Novell NetWare support](#)
- [Network configuration](#)



NOTE: For information about necessary network components for digital sending, see [Network components used for digital-sending on page 6](#)

Novell NetWare support

If Novell file servers are used on the network, HP DSS can write files into network folders and support network fax folders that reside on Novell servers. The Novell client software must be installed on the network and be configured correctly before Novell-specific attributes can be configured in HP DSS.

In order to support Novell NetWare authentication and Novell digital sending destinations, HP DSS requires both of the following components:

- Novell NetWare version 3.12, 3.2, 4.11, 4.2, 5, or 6 running on the Novell NetWare server
- AND-
- Novell NetWare Client version 4.6 (or later) installed on the Windows computer that runs HP DSS

Network configuration

You might need to configure certain network parameters on the device. You can configure these parameters in the following locations:

- Installation software
- Device control panel
- Embedded Web server
- Management software (HP Web Jetadmin or HP LaserJet Utility for Macintosh)



NOTE: For more information about using the embedded Web server, see the embedded Web server guide on the device CD.

For more information on supported networks and network configuration tools, see the *HP Jetdirect Print Server Administrator's Guide*. The guide comes with devices in which an HP Jetdirect print server is installed.

Configure TCP/IPv4 parameters

If your network does not provide automatic IP addressing through DHCP, BOOTP, RARP, or another method, you might need to enter the following parameters manually before you can scan over the network:

- IP address (4 bytes) (such as 192.168.1.1)
- Subnet mask (4 bytes)
- Default gateway (4 bytes)

Set an IP address

You can view the current IP address of the device from the control-panel Home screen by touching [Network Address](#).

Use the following procedure to change the IP address manually.

1. Scroll to and touch [Administration](#).
2. Scroll to and touch [Initial Setup](#).
3. Touch [Networking and I/O](#).
4. Touch [Embedded Jetdirect](#).
5. Touch [TCP/IP](#).
6. Touch [IPV4 Settings](#).
7. Touch [Config Method](#).
8. Touch [Manual](#).
9. Touch [Save](#).
10. Touch [Manual Settings](#).

11. Touch **IP Address**.
12. Touch the **IP Address** text box.
13. Use the touchscreen keypad to type the IP address.
14. Touch **OK**.
15. Touch **Save**.

Set the subnet mask

1. Scroll to and touch **Administration**.
2. Scroll to and touch **Initial Setup**.
3. Touch **Networking and I/O**.
4. Touch **Embedded Jetdirect**.
5. Touch **TCP/IP**.
6. Touch **IPV4 Settings**.
7. Touch **Config Method**.
8. Touch **Manual**.
9. Touch **Save**.
10. Touch **Manual Settings**.
11. Touch **Subnet Mask**.
12. Touch the **Subnet Mask** text box.
13. Use the touchscreen keypad to type the subnet mask.
14. Touch **OK**.
15. Touch **Save**.

Set the default gateway

1. Scroll to and touch **Administration**.
2. Scroll to and touch **Initial Setup**.
3. Touch **Networking and I/O**.
4. Touch **Embedded Jetdirect**.
5. Touch **TCP/IP**.
6. Touch **IPV4 Settings**.
7. Touch **Config Method**.
8. Touch **Manual**.
9. Touch **Save**.

10. Touch **Manual Settings**.
11. Touch **Default Gateway**.
12. Touch the **Default Gateway** text box.
13. Use the touchscreen keyboard to type the default gateway.
14. Touch **OK**.
15. Touch **Save**.

Configure TCP/IPv6 parameters

The digital sender has limited IPv6 capability on a network. JetDirect Inside or any EIO JetDirect card can connect to an IPv6 network, and the device can be viewed and configured through WebJet Admin and the embedded Web server, but it currently has no capability to perform any type of digital sending through IPv6. Digital send functionality is through IPv4 only. For information about configuring the device for a TCP/IPv6 network, see the *HP Jetdirect Print Server Administrator's Guide*.

HP Jetdirect EIO print servers

HP Jetdirect print servers (network cards) can be installed in the EIO slot. These cards support multiple network protocols and operating systems. HP Jetdirect print servers facilitate network management by allowing you to connect a device directly to your network at any location. HP Jetdirect print servers also support the Simple Network Management Protocol (SNMP), which provides remote device management and troubleshooting through the HP Web Jetadmin software.



NOTE: Configure the card through the control panel, the device installation software, or HP Web Jetadmin. Refer to the HP Jetdirect print server documentation for more information.

4 Use device features

This section provides instructions for how to carry out common digital-sending tasks.

- [Load media](#)
- [Use the keyboard](#)
- [Basic send information](#)
- [Configure the device to send e-mail](#)
- [Send an e-mail](#)
- [Scan to a folder](#)
- [Scan to a workflow destination](#)
- [Send a digital fax](#)

Load media

You can load media to scan either on the scanner glass or in the ADF.

Load media on the scanner glass

Use the scanner glass to scan small, lightweight (less than 60 g/m² or 16 lb), or irregularly-sized originals such as receipts, newspaper clippings, photographs, or old or worn documents.

- ▲ Place the document face-down on the scanner glass, with the top right-hand corner of the document on the upper right corner of the scanner glass.

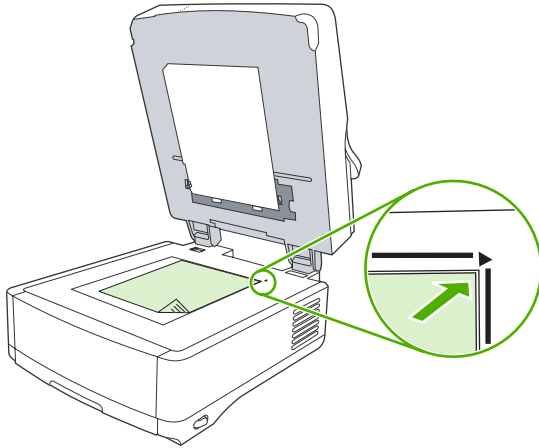

Load the automatic document feeder (ADF)

Use the ADF to scan a document that has up to 50 pages (depending on the thickness of the pages).

1. Load the document face-up in the ADF with the top of the document feeding into the ADF first.

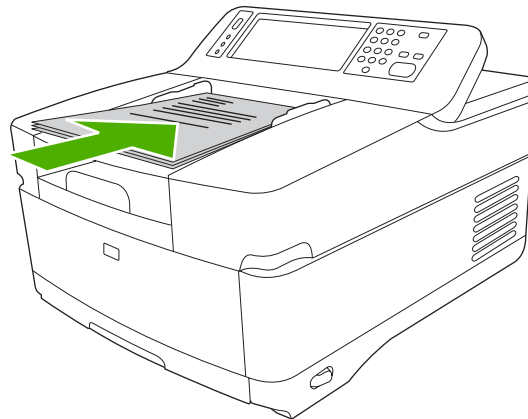

2. Slide the stack into the ADF until it does not move any farther.

3. Adjust the media guides until they are snug against the media.

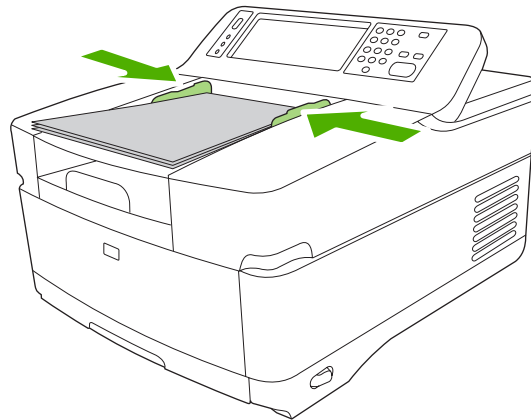

Use the keyboard

The digital sender has a built-in keyboard that can be used to type the necessary information when scanning a file to an e-mail address.

1. At the bottom of the device, pull out the keyboard tray.

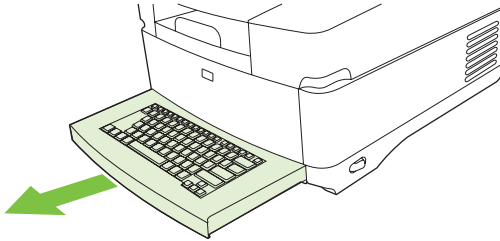

2. Type the necessary information in the active field on the device touchscreen. Use the following keys to navigate from the keyboard:
 - Press the **Escape** key to return to the previous screen.
 - Press the **Tab** key to move the cursor to the next field.
 - Press the **Start** button on the control panel to begin the scanning process.
3. When you are finished using the keyboard, push the keyboard tray into the device.

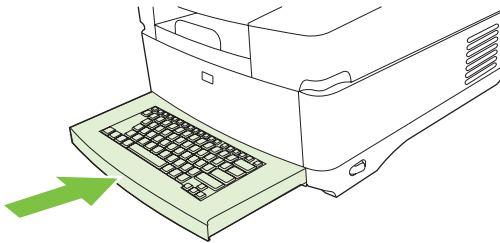

Basic send information

Log in

When you walk up to the digital sender, you will see the home screen. The options that are displayed are the digital-sending options that have been enabled by the system administrator.

The system administrator can configure the device to require a user name and password in order to use some or all of the digital-sender features. If you try to use a feature that requires authentication, a log-in screen appears.

1. Touch **Username**, and then type your network user name.
2. Touch **Password**, and then type your network password.

Contact your system administrator if you are unsure of what to use.

3. Depending on the network configuration, provide the necessary network information.
 - **Windows networking systems:** Provide the domain name.
 - **Novel Bindery:** Provide the server name.
 - **Novell NDS:** Provide the tree and context.
4. Touch **OK**.

After you have logged in, a **LOG OUT** button appears on the home screen. Touch this button, or press the **Reset** button on the control panel, to log out when you have finished your job. You are also automatically logged out after a period of inactivity. The default timeout setting is 60 seconds. The system administrator can change this setting.

Change settings for the current job

Use the **More Options** button in the Send E-mail, Send to Network Folder, or Send to Workflow screens to change the following settings for the current scan job:

Button	Description
Document File Type	<p>Touch this button to change the type of file the device creates after scanning the document. The file types are as follows:</p> <ul style="list-style-type: none">• .PDF: The .PDF file format is the default setting, and it offers the best overall text and graphics quality. However, the recipient must have an Adobe® Acrobat® viewer installed to read .PDF files. This file format produces one e-mail attachment that contains all the scanned pages.• .JPG: While a .JPG file does not have the same quality as a .PDF, the recipient can view a .JPG file easily with an Internet browser. This file format produces one e-mail attachment for each scanned page. The recipient can manipulate the .JPG files and import them into various programs.• .TIFF: This standard file format interfaces well with many computer programs and can be manipulated by the recipient. This file format produces one e-mail attachment for each scanned page.• .MTIFF: An .MTIFF is a multipage .TIFF file that saves multiple scanned pages into a single e-mail attachment.

 **NOTE:** If the network limits the file size of e-mail attachments, .MTIFF and .PDF files might be divided into multiple e-mail attachments.

Button	Description
Output Quality	Touch this button to increase or decrease the print quality of the file being scanned. A higher quality setting produces a larger file size.
Resolution	Touch this button to change the scan resolution. A higher resolution setting produces a larger file size.
Color/Black	Touch this button to determine whether you will scan the document in color or in black-and-white.
Original Sides	Touch this button to indicate if the original document is one-sided or two-sided.
Content Orientation	Touch this button to select either the portrait or landscape orientation for the original.
Original Size	Touch this button to select the size of the document: letter, A4, legal, or mixed letter/legal.
Optimize Text/ Picture	Touch this button to change the scanning procedure based on the type of document that you are scanning.
Job Build	Touch this button to activate or deactivate the Job Build mode, which enables you to scan several small scan jobs and send them as one file.
Image Adjustment	Touch this button to change the darkness and sharpness settings, or to clean up background clutter on the original.



NOTE: Once the job has been sent, the settings will revert to the default values. To change the default settings, use the [Default Job Options](#) menu under the [Administration](#) menu.

Cancel send

To cancel any send job, press the [Cancel](#) button on the control panel before the send process is complete.

Configure the device to send e-mail

Before you can send a document to e-mail, you must configure the device for e-mailing.



NOTE: You can also configure the e-mail settings by using the embedded Web server, which HP recommends. For helpful tips and more about configuring the scan e-mail feature, see the *Embedded Web Server User Guide* on the device documentation CD.

For more information on setting up a feature, solving a problem, or discovering how to use this device, go to www.hp.com/support/9250c.

Supported protocols

SMTP

- Simple Mail Transfer Protocol (SMTP) is a set of rules that define the interaction between programs that send and receive e-mail. In order for the device to send documents to e-mail, it must be connected to a LAN that has a valid SMTP IP address. The SMTP server must also have Internet access.
- If you are using a LAN connection, contact your system administrator to obtain the IP address for your SMTP server. If you are connecting through a DSL connection, contact the service provider to obtain the SMTP server IP address.

LDAP

- Lightweight Directory Access Protocol (LDAP) is used to gain access to a database of information. When the device uses LDAP, it searches a global list of e-mail addresses. As you begin to type the e-mail address, LDAP uses an auto-complete feature that supplies a list of e-mail addresses that match the characters you type. As you type additional characters, the list of matching e-mail addresses becomes smaller.
- The device supports LDAP, but a connection to an LDAP server is not required in order for the device to be able to send to e-mail.



NOTE: If you need to change the LDAP settings, you must change them by using the embedded Web server. For more information, see the *Embedded Web Server User Guide* on the device CD.

Configure e-mail server settings

Consult a network administrator or internet service provider (ISP) for the IP address or the name of the SMTP server. Or, find the IP address from the device control panel (touch Network Address). Then use the following procedures to manually configure and test the IP address.

Configure the SMTP gateway address

1. From the Home screen, touch **Administration**.
2. Touch **Initial Setup**.
3. Touch **E-mail Setup**, and then touch **SMTP Gateway**.

4. Type the SMTP gateway address, either as an IP address or as a fully qualified domain name. If you do not know the IP address or domain name, contact the network administrator.
5. Touch **OK**.

Test the SMTP settings

1. From the Home screen, touch **Administration**.
2. Touch **Initial Setup**.
3. Touch **E-mail Setup**, and then touch **Test Send Gateways**.

If the configuration is correct, **Gateways OK** appears on the control-panel display.

If the first test was successful, send an e-mail to yourself by using the digital-send feature. If you receive the e-mail, you have successfully configured the digital-sending feature.

If you do not receive the e-mail, use these actions to resolve issues with the digital-sending software:

- View the configuration page. Verify that the SMTP gateway address is correct.
- Make sure that the network is operating correctly. Send an e-mail to yourself from a computer. If you receive the e-mail, the network is operating correctly. If you do not receive the e-mail, contact your network administrator or Internet service provider (ISP).

Find gateways

If you do not know the e-mail server address, you can use one of the following methods to find it.

Find the SMTP gateway from the device control panel

1. From the Home screen, touch **Administration**.
2. Touch **Initial Setup**.
3. Touch **E-mail Setup**, and then touch **Find Send Gateways**.

The touchscreen displays a list of detected SMTP servers.

4. Select the correct SMTP server, and then touch **OK**.

Find the SMTP gateway from an e-mail program

Because most e-mail programs also use SMTP to send e-mail and LDAP to address e-mail messages, you might be able to find the hostname of the SMTP gateway and LDAP server by looking at the settings for your e-mail program.



NOTE: The find gateway features might be unable to detect a valid SMTP server on the network if it uses an internet service provider (ISP). To find the ISP e-mail server address, contact the ISP.

Send an e-mail

The device scans both black-and-white and color originals. You can use default settings or change the scanning preferences and file formats. The following are the default settings:

- Color
- PDF (requires the recipient to have an Adobe Acrobat viewer to view the e-mail attachment)

Use the Send E-mail screen

Use the touchscreen to navigate through the options on the Send E-mail screen.

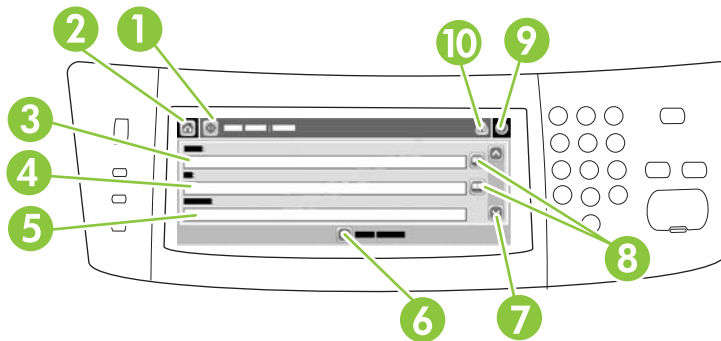

1	Send E-mail button	Touching this button scans the document and sends an e-mail file to the provided e-mail addresses.
2	Home button	Touching this button opens the Home screen.
3	From: field	Touch this field to open the keyboard, and then type your e-mail address. If the system administrator has configured the device to do so, this field might automatically insert a default address.
4	To: field	Touch this field to open the keyboard, and then type the e-mail addresses of those whom you want to receive the scanned document.
5	Subject: field	Touch this field to open the keyboard, and then type a subject title.
6	More Options button	Touch this button to change certain e-mail settings for the current scan job.
7	Scroll bar	Use the scroll bar to view and set up the CC:, BCC:, Message, and File Name fields. Touch any of those fields to open the keyboard and add the necessary information.
8	Address book buttons	Touch these buttons to use the address book to populate the To:, CC:, or BCC: fields. For more information, see Use the address book on page 46 .
9	Help button	Touch this button for control-panel help. For more information, see Use the control panel on page 12 .
10	Error/warning button	This button appears only when there is an error or warning in the status line area. Touch it to open a pop-up screen that will help you resolve the error or warning.

Send a document

1. Place the document face-down on the scanner glass or face-up in the ADF.
2. From the Home screen, touch **E-mail**.

3. If prompted, type your user name and password.
4. Complete the **From:**, **To:**, and **Subject:** fields. Scroll down and complete the **CC:**, **BCC:**, and **Message** fields if appropriate. Your user name or other default information might appear in the **From:** field. If so, you might not be able to change it.
5. (Optional) Touch **More Options** to change the settings for the document that you are sending (for example, the document's original size). If you are sending a two-sided document, you should select **Sides** and an option with a two-sided original.
6. Press **Start** to begin sending.
7. When you are finished, remove the original document from the scanner glass or ADF.

Use the auto-complete function

When you type characters into the **To:**, **CC:**, or **From:** fields on the Send E-mail screen, the auto-complete function is activated. As you type the required address or name by using the keyboard screen, the device automatically searches the address book list and completes the address or name by using the first match. You can then select that name by touching **Enter**, or continue typing the name until auto-complete finds the correct entry. If you type a character that does not match any entry in the list, the auto-complete text is removed from the display to indicate that you are typing an address that is not in the address book.



Use the address book

You can send e-mail to a list of recipients by using the address book feature of the device. See your system administrator for information about configuring address lists.



NOTE: You can also use the embedded Web server to create and manage the e-mail address book. For more information, see the embedded Web server guide on the device CD.

Create a recipient list

1. From the Home screen, touch **E-mail**.
2. Complete one of the following steps:
 - Touch **To:** to open the keyboard screen, and then type the recipients' e-mail addresses. Separate multiple e-mail addresses with a semicolon or by touching **Enter** on the touchscreen.
 - Use the address book.
 - a. On the Send E-mail screen, touch the address book button () to open the address book.
 - b. Navigate the entries in the address book by using the scroll bar. Hold down the arrow to scroll quickly through the list.
 - c. Highlight the name to select a recipient, and then touch the add button ()

You can also select a distribution list by touching the drop-down list at the top of the screen and then touching **All**, or add a recipient from a local list by touching **Local** in the drop-down list. Highlight the appropriate names, and then touch  to add the name to your list of recipients.

You can remove a recipient from your list by scrolling to highlight the recipient, and then touching the remove button (✖).

3. The names in the recipient list are placed in the text line of the keyboard screen. If you want, you can add a recipient that is not found in the address book by typing the e-mail address on the keyboard. After you are satisfied with your recipient list, touch **OK**.
4. Touch **OK**.
5. Finish typing information in the **CC:** and **Subject:** fields on the Send E-mail screen, if necessary. You can check the list of recipients by touching the down arrow in the **To:** text line.
6. Press **Start**.

Use the local address book

Use the local address book to store frequently used e-mail addresses. If using HP Digital Sending Software, the local address book also can be shared between devices that use the same DSS server.

You can use the address book when you type e-mail addresses in the **From:**, **To:**, **CC:**, or **BCC:** fields. You can also add or delete addresses in the address book.

To open the address book, touch the address book button (📁).

Add e-mail addresses to the local address book

1. Touch **Local**.
2. Touch (⊕).
3. (Optional) Touch the **Name** field, and in the keyboard that appears type a name for the new entry. Touch **OK**.

The name is the alias for the e-mail address. If you do not type an alias name, the alias will be the e-mail address itself.

4. Touch the **Address** field, and in the keyboard that appears type the e-mail address for the new entry. Touch **OK**.

Delete e-mail addresses from the local address book

You can delete e-mail addresses that you no longer use.



NOTE: To *change* an e-mail address, you must first delete the address and then add the corrected address as a new address in the local address book.

1. Touch **Local**.
2. Touch the e-mail address that you want to delete.
3. Touch (✖).

The following confirmation message appears: **Do you want to delete the selected address(es)?**

4. Touch **Yes** to delete the e-mail address(es) or touch **No** to return to the Address Book screen.

Scan to a folder

If the system administrator has made the feature available, the device can scan a file and send it to a folder on the network. Supported operating systems for folder destinations include Windows 2000, Windows XP, and Windows Server 2003, and Novell.

1. Place the document face-down on the scanner glass or face-up in the ADF.
2. From the Home screen, touch **Network Folder**.
3. In the **Quick Access Folders** list, select the folder in which you want to save the document.
4. Touch the **File Name** field to open the keyboard pop-up screen, and then type the file name.
5. Touch **Send to Network Folder**.

Scan to a workflow destination



NOTE: This device feature is provided by the optional Digital Sending Software product.

If the system administrator has enabled the workflow functionality, you can scan a document and send it to a custom workflow destination. A workflow destination gives you the ability to send additional information, along with the scanned document, to a specified network or file transfer protocol (FTP) location. Prompts for specific information appear on the control-panel display. The system administrator can also designate a printer as a workflow destination, which allows you to scan a document and then send it directly to a network printer for printing.

1. Place the document face-down on the scanner glass or face-up in the ADF.
2. From the Home screen, touch **Workflow**.
3. Select the destination to which you want to scan.
4. In the **Text Field** field, type the data that you want to accompany the file, and then touch **Send Workflow**.

Send a digital fax

Digital faxing is available when you install the optional HP Digital Sending Software. For information about ordering this software, go to www.hp.com/go/9250c_software.

With digital faxing, the device does *not* need to be connected directly to a phone line. Instead, the device can send a fax in one of three ways:

- **LAN fax** sends faxes through a third-party fax provider.
- **Microsoft Windows 2000 fax** is a fax modem and digital sender module that the computer uses to operate as a turnkey gateway fax.
- **Internet fax** uses an Internet fax provider to process faxes. The fax is delivered to a traditional fax machine or sent to the user's e-mail.

For complete information about using digital faxing, see the documentation that is provided with the HP Digital Sending Software.

5 Manage and maintain the device

This chapter describes how to manage and maintain the device:

- [Use information pages](#)
- [Use the embedded Web server](#)
- [Use HP Web Jetadmin software](#)
- [Controlling digital-sending security](#)
- [Replace supplies and parts](#)
- [Clean the device](#)
- [Upgrade the firmware](#)
- [Calibrate the scanner](#)

Use information pages

From the control panel touchscreen, view pages that give details about the device and its current configuration.

Page description	How to view the page
Configuration page Shows device settings and installed accessories.	<ol style="list-style-type: none">1. From the Home screen, touch Administration.2. Touch Information.3. Touch Configuration/Status Pages.4. Touch Configuration Page.5. Touch Show.
	 NOTE: If the device contains an HP Jetdirect print server or an optional hard disk drive, additional configuration pages that provide information about those devices appear.
Usage page Shows a page count for each size of paper scanned, the number of one-sided (simplex) or two-sided (duplexed) pages, and the average percentage of coverage.	<ol style="list-style-type: none">1. From the Home screen, touch Administration.2. Touch Information.3. Touch Configuration/Status Pages.4. Touch Usage Page.5. Touch Show.

Use the embedded Web server



NOTE: If you use the HP Digital Sending Software provided on the digital sender software CD, you must use the HP MFP DSS Configuration Utility to perform the functions below described in this section. See the *HP Digital Sending Software Support Guide* on the documentation CD for configuration instructions.

- View device control status information
- View and change the device control panel menu configuration
- View internal pages
- Receive notification of device events
- View and change network configuration
- View support content that is specific to the current state of the device

When the device is connected to the network, the embedded Web server is automatically available.

To use the embedded Web server, you must have Microsoft Internet Explorer 4 and later or Netscape Navigator 4 and later. The embedded Web server works when the device is connected to an IP-based network. The embedded Web server does not support IPX-based or AppleTalk printer connections. You do not need Internet access to open and use the embedded Web server.

Open the embedded Web server by using a network connection

1. In a supported Web browser on your computer, type the device IP address or host name in the address/URL field. To find the IP address or host name, either touch the **Network Address** button on the device control panel touchscreen or view the configuration page.





NOTE: After you open the URL, you can bookmark it so that you can return to it quickly in the future.

2. The embedded Web server has three tabs that contain settings and information about the device: the **Information** tab, the **Settings** tab, and the **Networking** tab. Click the tab that you want to view.

See [Embedded Web server sections on page 54](#) for more information about each tab.

Embedded Web server sections

Tab or section	Options
Information tab Provides device, status, and configuration information	<ul style="list-style-type: none">● Device Status: Shows the device status. To change the default settings, click Change Settings.● Configuration Page: Shows the information found on the configuration page.● Supplies Status: Shows supplies ordering and recycling information. To order new supplies, click Shop for Supplies in the Other Links area on the left side of the window.● Event log: Shows a list of all device events and errors.● Usage page: Shows a summary of the number of pages the device has scanned, grouped by size and type.● Device Information: Shows the device network name, address, and model information. To change these entries, click Device Information on the Settings tab.● Control Panel: Shows messages from the device control panel, such as Ready or Sleep mode on.
Settings tab Provides the ability to configure the device from your computer	<ul style="list-style-type: none">● Configure Device: Allows you to configure device settings. This page contains the traditional menus found on devices using a control-panel display.● E-mail Server: Used in conjunction with the Alerts page to set up incoming and outgoing e-mail, as well as to set e-mail alerts.● Alerts: Allows you to set up to receive e-mail alerts for various device and supplies events.● AutoSend: Allows you to configure the device to send automated e-mails regarding device configuration and supplies to specific e-mail addresses.● Security: Allows you to set a password that must be entered to gain access to the Settings and Networking tabs. Enable and disable certain features of the embedded Web server.● Authentication Manager: Allows you to set the device functions that require users to successfully log in before use.● LDAP Authentication: Allows you to configure the digital sender to authenticate against an LDAP server.● Kerberos Authentication: Allows you to configure the digital sender to authenticate against a Kerberos Domain Controller.● Edit Other Links: Allows you to add or customize a link to another Web site. This link is displayed in the Other Links area on all embedded Web server pages.● Device Information: Allows you to name the device and assign an asset number to it. Enter the name and e-mail address for the primary contact who will receive information about the device.● Language: Allows you to determine the language in which to display the embedded Web server information.● Date & Time: Allows time synchronization with a network time server.● Wake Time: Allows you to set or edit a wake time for the device.

Tab or section	Options
	 <p>NOTE: The Settings tab can be password-protected. If this device is on a network, always consult with the system administrator before changing settings on this tab.</p>
<p>Digital Sending tab</p> <p>Provides the ability to configure device digital sending settings from your computer</p>	<ul style="list-style-type: none"> ● General Settings: Allows you to provide or change administrator information. ● E-mail Settings: Allows you to change such e-mail settings as e-mail server address, authentication requirements, and the default From address. ● Send to Folder: Allows you to enable or disable the send-to-folder feature, define network folders that can receive files, and set network folder settings. ● Addressing: Allows you to configure the device to use an LDAP address book and server. ● Address book: Allows you to add a predefined list of destination e-mail addresses to the device address book. ● Log: Allows you to view digital sending job information, including any errors that occur. ● Preferences: Allows you to configure general settings for the digital-sending features, such as the default scanner settings.
<p>Networking tab</p> <p>Provides the ability to change network settings from your computer</p>	<p>Network administrators can use this tab to control network-related settings for the device when it is connected to an IP-based network. This tab does not appear if the device is directly connected to a computer, or if the device is connected to a network using anything other than an HP Jetdirect print server.</p> <hr/>  <p>NOTE: The Networking tab can be password-protected.</p>
<p>Other links</p> <p>Contains links that connect you to the Internet</p>	<ul style="list-style-type: none"> ● HP Instant Support™: Connects you to the HP Web site to help you find solutions. This service analyzes your device error log and configuration information to provide diagnostic and support information specific to your device. ● Shop for Supplies: Connects to the HP SureSupply Web site, where you will receive information on options for purchasing original HP supplies, such as the ADF maintenance kit or paper. ● Product Support: Connects to the support site for the device, from which you can search for help regarding general topics. <hr/>  <p>NOTE: You must have Internet access in order to use any of these links. If you use a dial-up connection and did not connect when you first opened the embedded Web server, you must connect before you can visit these Web sites. Connecting might require that you close the embedded Web server and reopen it.</p>

Use HP Web Jetadmin software

HP Web Jetadmin is a Web-based software solution for remotely installing, monitoring, and troubleshooting network-connected peripherals. The intuitive browser interface simplifies cross-platform management of a wide range of devices, including HP and non-HP devices. Management is proactive, allowing network administrators the ability to resolve issues before users are affected. Download this free, enhanced-management software at www.hp.com/go/webjetadmin_software.

To obtain plug-ins to HP Web Jetadmin, click **plug-ins**, and then click the **download** link that is next to the name of the plug-in that you want. The HP Web Jetadmin software can automatically notify you when new plug-ins are available. On the **Product Update** page, follow the directions to automatically connect to the HP Web site.

If installed on a host server, HP Web Jetadmin is available to any client through a supported Web browser, such as Microsoft Internet Explorer 6.0 for Windows or Netscape Navigator 7.1 for Linux. Browse to the HP Web Jetadmin host.



NOTE: Browsers must be Java-enabled. Browsing from an Apple PC is not supported.

Controlling digital-sending security

The digital sender has been designed with security in mind. It includes a variety of features that work to protect the security of the digital-sending process.

Network authentication

The digital sender's most basic security feature is its ability to require a network login before a user can use the digital sending functions. This prevents unauthorized users from walking up to the device and sending documents. Additionally, the digital sender supports several authentication methods that offer a high level of encryption and security.

Secure e-mail

A number of third-party software vendors offer services for secure e-mail delivery. The **Secondary e-mail** feature is designed to work with one of these third-party software programs for users that require an extra measure of data security. For more information, see the DSS support guide.

Restrict software access

In order to keep the digital sender secure, you must also restrict access to the software programs that can be used to configure the device. By default, the digital-sending configuration options in the embedded Web server (EWS) are disabled when the digital sender begins using the HP DSS service. The digital sender can then only be configured by using the HP MFP DSS Configuration Utility. This centralizes configuration tasks and helps control security. You should make sure that the HP DSS is installed on a secure server and that the HP MFP DSS Configuration Utility cannot be used by unauthorized users.

In addition, you can also set a password in EWS to prevent access to the device-settings tabs. After the password has been set, users can only see the EWS **Information** tab. For more information about the **Security** page, see the embedded Web server guide on the device CD.

The final software program that can be used to control the digital sender is the HP Web Jetadmin program. This program can also be configured to require a password before any changes can be made. It should also be installed on a secure server and should be protected from unauthorized use.

Security lock

The security lock is a mechanical lock that prevents the removal of internal device components. The lock used is a third-party computer lock such as the ones that are used to secure laptop computers. Purchase the lock separately, and then install it on the device in the location shown in this figure.

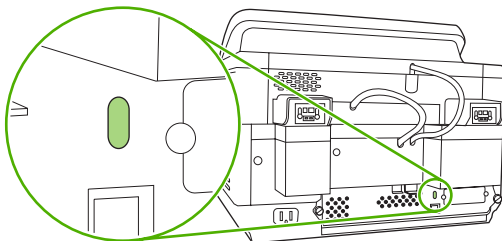

Replace supplies and parts

Replace the mylar sheet

If you start to see vertical streaks on the scanned images, as shown in the figure below, you might need to replace the mylar sheet at the base of the ADF. The device ships with an envelope containing three extra mylar sheets and installation instructions. The envelope is in a pocket behind the ADF vinyl backing, as shown in the following figure.

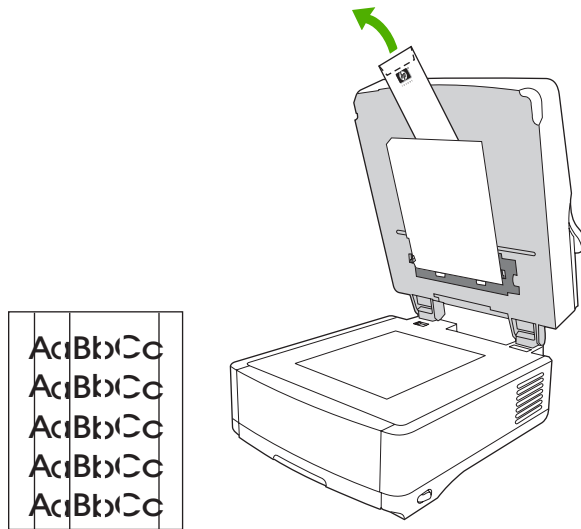

Follow the instructions that come in the envelope to replace the mylar sheet.



NOTE: If necessary, you can order extra mylar sheet replacement kits from your HP sales representative. The HP part number is Q6496A.

Replace the ADF Maintenance Kit

The device notifies you when it is time to replace the ADF Maintenance Kit by showing a message on the control-panel display. You can view the remaining life of the Maintenance Kit at any time by pressing the **Status** button on the control panel or visiting the EWS **Supplies Status** page (see the embedded Web server guide on the device CD).

The ADF Maintenance Kit includes the following items:

- One pickup roller assembly
- One separation pad
- One mylar sheet kit
- An instruction booklet

Follow the instructions that come with the kit to install it.

After replacing the kit, reset the **New Document Feeder Kit** setting.

1. On the Home screen, touch **Administration**.
2. Scroll down and touch **Resets**.
3. Touch **Reset Supplies**.
4. Touch **New Document Feeder Kit**.
5. Touch **Yes**, and then touch **Save**.

Clean the device

During the scanning process, paper and dust particles can accumulate inside the device. Over time, this buildup can cause problems, such as specks on scanned documents.

Clean the exterior

Use a soft, damp, lint-free cloth to wipe dust, smudges, and stains off of the exterior of the device.

Clean the glass

- Clean the glass only if dirt is visible, or if you see poor scan quality (such as streaking).
- Clean the glass surface by wiping it gently with a clean, damp, lint-free cloth. Use an ammonia-based surface cleaner to dampen the cloth.



CAUTION: Do not pour or spray liquids directly onto the glass. Do not press hard on the glass surface, as this could break the glass.

Clean the touchscreen

Clean the touchscreen when needed to clear away fingerprints or dust build-up. To clean it, wipe the touchscreen gently with a clean, water-dampened, lint-free cloth.



CAUTION: Use water only. Solvents or cleaners can damage the touchscreen. Do not pour or spray water directly onto the touchscreen.

Clean the ADF delivery system

1. Lift the top part of the digital sender.

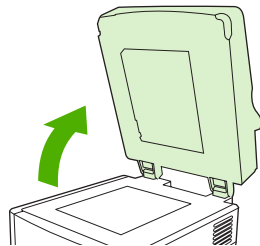

2. Locate the white, vinyl ADF backing.

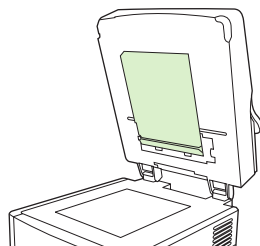

3. Locate the white, vinyl calibration strips.

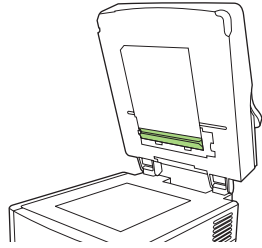

4. Clean the ADF backing and the calibration strips by wiping them with a clean, damp, lint-free cloth. Use an ammonia-based surface cleaner to dampen the cloth.

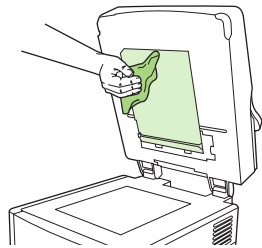

5. Close the top of the digital sender.

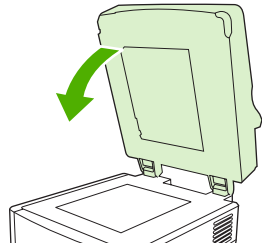

Clean the ADF rollers

You should clean the rollers in the ADF if you are experiencing misfeeds or if your originals show marks as they exit the ADF.



CAUTION: Cleaning the rollers too frequently could introduce dust into the device.

1. Open the scanner lid.

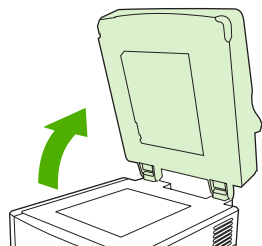

2. Locate the rollers near the vinyl calibration strips.

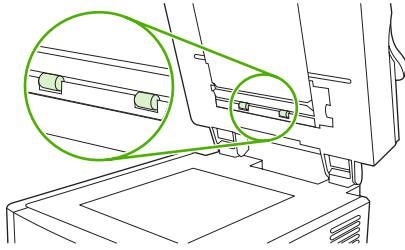

3. Wipe the rollers gently with a clean, water-dampened, lint-free cloth.

 **CAUTION:** Do not pour water directly onto the rollers. Doing so might damage the device.

4. Close the scanner lid.

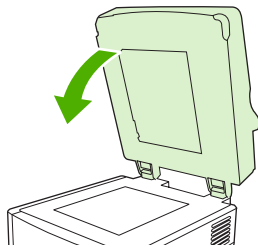

5. Push the release button to open the ADF cover.

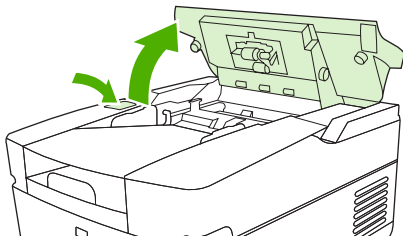

6. Locate the rollers.

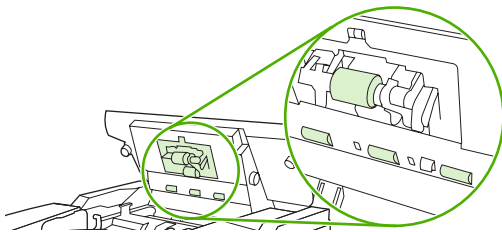

7. Wipe the rollers with a clean, water-dampened, lint-free cloth.

 **CAUTION:** Do not pour water directly onto the rollers. Doing so might damage the device.

8. Locate the separation pad.

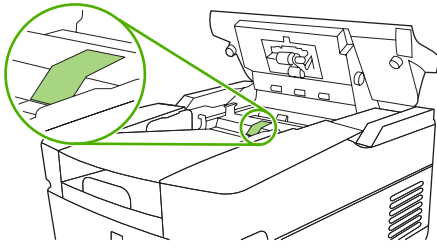

9. Wipe the pad with a clean, water-dampened, lint-free cloth.
10. Close the ADF cover.

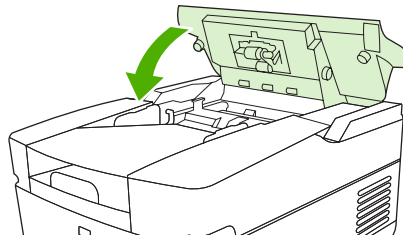

Upgrade the firmware

The HP 9250C Digital Sender features remote firmware update (RFU) capability. Use the following steps for remotely upgrading digital-sender firmware. These steps are explained in more detail in the following sections.

1. Determine the current level of firmware installed on the device.
2. Go to the Web site and find out whether a new version is available. If it is, download the latest firmware to your computer.
3. Download the new firmware to the device.

Determine the current level of firmware

1. Open the configuration page on the device control panel. See [Use information pages on page 52](#)
2. Scroll to the configuration section marked **Device Information** to find the firmware date code. The firmware date code looks something like this: 20030502 05.003.0

Download new firmware from the HP Web site

To find the most recent firmware upgrade for the digital sender, go to www.hp.com/go/9250c_firmware. This page also contains instructions about how to download the new firmware version.

Download the new firmware version from the Web site, and then use one of the methods in the following sections to update the digital sender firmware.

Use FTP to upgrade the firmware on a direct network connection

The device must be in a "Ready" state to receive an .RFU file update. Any jobs that are ahead of the RFU job in the queue are completed before the update is processed.

The elapsed time for an update depends on the I/O transfer time, as well as the time that it takes for the device to reinitialize. The I/O transfer time depends on a number of things, including the speed of the host computer that is sending the update. If the remote firmware update process is interrupted before the firmware is downloaded (while **Receiving Upgrade** appears on the control-panel display), the firmware file must be sent again. If power is lost during the flash DIMM update (while the **Performing Upgrade** message appears on the control-panel display), the update is interrupted and the message **Resend Upgrade** appears (in English only) on the control-panel display.

Follow these instructions to perform the upgrade by using FTP.



NOTE: The firmware update involves a change in the format of nonvolatile random-access memory (NVRAM). Any menu settings that are changed from the default settings might return to default settings and must be changed again if you want settings that are different from the defaults.

1. If you do not already have it, get the TCP/IP address of the digital sender from the EIO Jetdirect page. The HP Jetdirect page is the second page that you see when viewing the configuration page on the control panel.



NOTE: Before connecting to the digital sender, make sure that it is not in Sleep mode. Also make sure that any error messages are cleared from the control-panel display.

2. Open a command window on your computer.
3. Type: `ftp <TCP/IP ADDRESS>`. For example, if the TCP/IP address is 192.168.0.90, type `ftp 192.168.0.90`.
4. Press **Enter** on the keyboard.
5. When prompted for the user name, press **Enter**.
6. When prompted for the password, press **Enter**.
7. Type `bin` at the command prompt.
8. Press **Enter**. The message **200 Types set to I, Using binary mode to transfer files** appears in the command window.
9. Type `put <FILENAME>`, where `<FILENAME>` is the path to the .RFU file that was downloaded from the Web. For example, type `put C:\LJ\9250FW.RFU`, and then press **Enter**.



NOTE: If the file name or path includes a space, you must enclose the file name or path in quotation marks. For example, type `put "C:\MY DOCUMENTS\LJ\9250FW.RFU"`

The following series of messages appears in the command window:

200 PORT command successful

150 Opening BINARY mode data connection

226 Ready

226 Processing Job

226 Transfer complete

Then, a message containing transfer-speed information appears.

10. The download process begins and the firmware is updated on the device. This can take about five minutes. Let the process finish without further interaction with the device or computer.



NOTE: The digital sender automatically restarts the firmware after processing the upgrade.

11. At the command prompt, type `bye` to exit the ftp command.
12. At the command prompt, type `exit` to return to the Windows interface.

Use a USB connection to upgrade the device firmware

If the device is connected over a USB connection, follow these instructions:

1. From a command prompt or in an MS-DOS window, type `copy /b <FILENAME>\<COMPUTERNAME>\<SHARENAME>`, where `<FILENAME>` is the name of the .RFU file (including the path), `<COMPUTERNAME>` is the name of the computer from which the device is being shared, and `<SHARENAME>` is the device share name. For example, type the following:

```
copy /b 3000fw.rfu\\your_computer\9250c
```



NOTE: If the file name or path includes a space, you must enclose the file name or path in quotation marks. For example, type `C:\>copy /b "c:\My Documents \xxxxfw.rfu" \\your_computer\clj3000`.

2. Press **Enter** on the keyboard. After several status messages appear on the device control panel, the message **1 file(s) copied** appears on the computer screen.
3. The download process begins and the firmware is updated on the device. This can take several minutes. Let the process finish without further interaction with the device or the computer.



NOTE: The device automatically turns off and then on again to activate the update; this can happen more than once. At the end of the update process, the **Ready** message appears on the control panel. Do *not* turn off the device or interfere with the update until you see this message.

4. At the device control panel, open the configuration page and verify that the firmware revision number matches the revision of the current update.

Use HP Web Jetadmin to upgrade the firmware

This procedure requires that you have HP Web Jetadmin Version 7.0 or later installed (see [Use HP Web Jetadmin software on page 56](#)). Complete the following steps to update a single device through HP Web Jetadmin after downloading the .RFU file from the HP Web site.

1. Start HP Web Jetadmin.
2. Open the **Device Management** folder in the drop-down list in the **Navigation** panel. Navigate to the **Device Lists** folder.
3. Expand the **Device Lists** folder and select **All Devices**. Locate the digital sender that you want to update in the list of devices, and then click to select it.
4. Locate the drop-down box for **Device Tools** in the upper-right corner of the window. Select **Update Printer Firmware** from the action list.
5. Click **Browse** under **Upload New Firmware Image** and navigate to the location of the .RFU file that you downloaded from the Web at the start of this procedure. Select the file.
6. Click **Upload** to move the .RFU file to the correct location on the HP Web Jetadmin server. After the upload is complete, the browser window refreshes.
7. Select the new .RFU date code from the **Select New Firmware Version** drop-down menu.
8. Click **Update Firmware Now**. HP Web Jetadmin sends the selected .RFU file to the device. The digital-sender control panel shows messages that indicate the progress of the upgrade. At the end of the upgrade process, the digital sender restarts the firmware.

Upgrade the HP Jetdirect Inside firmware

The HP Jetdirect Inside network interface in the device has firmware that can be upgraded separately from the digital-sender firmware. This procedure requires that you have HP Web Jetadmin Version 6.2 or greater installed. Complete the following steps to update the HP Jetdirect firmware with HP Web Jetadmin.

1. Open the Web Jetadmin program.
2. Open the **Device Management** folder in the drop-down list in the **Navigation** panel. Navigate to the **Device Lists** folder.
3. Select the device that you want to update.
4. In the **Device Tools** drop-down list, select **Jetdirect Firmware Update**.
5. Under **Jetdirect firmware version** the Jetdirect model number and current firmware version are listed. Make a note of these.
6. Go to www.hp.com/go/wja_firmware.
7. Scroll down to the list of Jetdirect model numbers and find the model number that you wrote down.
8. Look at the current firmware version for the model, and see if it is later than the version that you wrote down. If it is, right-click on the firmware link, following the instructions on the Web page to download the new firmware file. The file must be saved into <drive>:\PROGRAM FILES\HP WEB JETADMIN\DOC\PLUGINS\HPWJA\FIRMWARE\JETDIRECT on the computer that is running the HP Web Jetadmin software.
9. In Web Jetadmin, return to the main device list and select the digital sender again.
10. In the **Device Tools** drop-down list, select **Jetdirect Firmware Update** again.
11. On the Jetdirect firmware page, the new firmware version appears under **Jetdirect Firmware Available on HP Web Jetadmin**. Click the **Update Firmware Now** button to update the Jetdirect firmware.

Calibrate the scanner

Calibrate the scanner to compensate for offsets in the scanner imaging system (carriage head) for ADF and flatbed scans. Because of mechanical tolerances, the scanner's carriage head might not read the position of the image accurately. During the calibration procedure, scanner offset values are calculated and stored. The offset values are then used when producing scans so that the correct portion of the document is captured.

Scanner calibration should be carried out only if you notice offset problems with the scanned images. The scanner is calibrated before it leaves the factory. It needs to be calibrated again only rarely.

1. From the Home screen, touch **Administration**.
2. Touch **Troubleshooting**.
3. Place the calibration sheet that came with the digital sender on the flatbed scanner.



NOTE: If you do not have the calibration sheet that came with the digital sender, go to www.hp.com/go/9250c_scanner_cal to download and then print the sheet.

4. Touch **Calibrate Scanner** and then follow the instructions in the onscreen dialog box.

The device starts the calibration process, and **Calibrating** appears on the touchscreen status line until the process is complete.

6 Problem solving

This information is organized to help you resolve device problems. Choose the general topic or type of problem from the following list.

- [Sources for information about problems](#)
- [Control-panel messages](#)
- [Jams](#)
- [Solve e-mail problems](#)

Sources for information about problems

Source	Description
Control-panel lights	<ul style="list-style-type: none">● Start LED light—The Start LED light is green when the device is ready to scan, and amber if an error exists.● Ready LED light—The green Ready LED light is on when the device is online and ready to scan. It flashes when a job is paused. It is off if the device is paused or unable to send data.● Data LED light—The green Data LED light is on when the device is processing a job but has been paused. It is off when no job is available to be processed. It flashes when the device is transmitting data.● Attention LED light—If the red Attention LED light is on, the device has encountered a critical error. If it flashes, the device has encountered an error that requires user attention. If it is off, the device is operating normally.● Sleep LED light—If the green Sleep LED light is on, the device is in Sleep mode. Press the Sleep button or touch the device touchscreen to exit Sleep mode. <p>See Control-panel layout on page 12 for the location of these LED lights.</p>
Control-panel messages	Messages appear on the control-panel display when problems exist. See Resolve control-panel messages on page 71 for a list of messages and recommended actions.
Event log	The event log is a record of digital sender use. It contains messages (information, warning, or error) that can help you resolve problems. See Troubleshooting menu on page 30 .
HP Web Jetadmin software	This tool can be used to monitor and troubleshoot the digital sender. See Use HP Web Jetadmin software on page 56 for more information. You can also see the diagnostics and troubleshooting topics in the HP Web Jetadmin software online help for details.
Embedded Web server (EWS)	Use the EWS to view digital-sender status information, determine the remaining life on the ADF Maintenance Kit, view and print internal pages, receive notification of digital-sender events, and view and change the network configuration. See the embedded Web server guide on the device CD for more information.
HP MFP DSS Configuration Utility or Windows event log error messages	If an error occurs with the HP DSS software you might see an error message appear in the HP MFP DSS Configuration Utility or in the Windows event log. See the DSS support guide for information on these error messages.

Control-panel messages

Control-panel message types

Four types of control-panel messages can indicate the status of or problems with the device.

Message type	Description
Status messages	Status messages reflect the current state of the device. They inform you of normal device operation and require no interaction to clear them. They change as the state of the device changes. Whenever the device is ready, not busy, and has no pending warning messages, the status message Ready appears if the device is online.
Warning messages	Warning messages inform you of data and scan errors. These messages typically alternate with the Ready or status messages and remain until you touch OK . Some warning messages are clearable. If Clearable Warnings is set to Job on the device Device Behavior menu, the next job clears these messages.
Error messages	<p>Error messages communicate that some action must be performed, such as clearing a jam.</p> <p>Some error messages are auto-continuable. If Auto-Continue is set on the menus, the device will continue normal operation after an auto-continuable error message appears for 10 seconds.</p> <p> NOTE: Pressing any button during the 10-second auto-continuable error message overrides the auto-continue feature, and the button function takes precedence. For example, pressing the Stop button pauses scanning and offers the option to cancel the job.</p>
Critical-error messages	Critical error messages inform you of a device failure. Some of these messages can be cleared by turning the device off and then on. These messages are not affected by the Auto-Continue setting. If a critical error persists, service is required.

Resolve control-panel messages

Table 6-1 Control-panel messages

Control panel message	Description	Recommended action
11.XX - Internal clock error To continue touch OK	The device real time clock has experienced an error.	<p>Whenever the device is turned off and then turned on again, set the time and date at the control panel. See Time/Scheduling menu on page 19.</p> <p>If the error persists, you might need to replace the formatter.</p>
30.1.YY Scanner failure	An error has occurred in the scanner.	<p>Turn the device off and then on.</p> <p>If this message persists, contact an HP-authorized service or support provider. (See the HP support flyer, or go to www.hp.com/support/9250c.)</p>
49.XXXXX ERROR To continue turn off then on	A critical firmware error has occurred.	<p>Turn the device off, and then turn the device on.</p> <p>If this message persists, contact an HP-authorized service or support provider. (See the HP support flyer, or go to www.hp.com/support/9250c.)</p>

Table 6-1 Control-panel messages (continued)

Control panel message	Description	Recommended action
54.XX ERROR To continue turn off then on	A temporary error has occurred.	Turn the device off, and then turn the device on. If this message persists, contact an HP-authorized service or support provider. (See the HP support flyer, or go to www.hp.com/support/9250c .)
57.X ERROR To continue turn off then on	A temporary error has occurred.	Turn the device off, and then turn the device on. If this message persists, contact an HP-authorized service or support provider. (See the HP support flyer, or go to www.hp.com/support/9250c .)
58.XX ERROR To continue turn off then on	A temporary error has occurred.	Turn the device off, and then turn the device on. If this message persists, contact an HP-authorized service or support provider. (See the HP support flyer, or go to www.hp.com/support/9250c .)
59.XY ERROR To continue turn off then on	A temporary error has occurred.	Turn the device off, and then turn the device on. If this message persists, contact an HP-authorized service or support provider. (See the HP support flyer, or go to www.hp.com/support/9250c .)
79.XXXX ERROR To continue turn off then on	A critical hardware error occurred.	Turn the device off, and then turn the device on. If this message persists, contact an HP-authorized service or support provider. (See the HP support flyer, or go to www.hp.com/support/9250c .)
8X.YYYY EIO ERROR To continue turn off then on	The EIO accessory card has encountered a critical error, as specified by YYYY .	Try the following actions to clear the message. <ol style="list-style-type: none">1. Turn the device off, and then turn the device on.2. Turn the device off, reinstall the EIO accessory, and then turn the device on.3. Replace the EIO accessory.
8X.YYYY EMBEDDED JETDIRECT ERROR To continue turn off then on	The embedded HP Jetdirect print server has encountered a critical error, as specified by YYYY .	Turn the device off, and then turn the device on. If this message persists, contact an HP-authorized service or support provider. (See the HP support flyer, or go to www.hp.com/support/9250c .)
Access denied menus locked	The control panel function that you are trying to use has been locked to prevent unauthorized access.	Contact the network administrator.

Table 6-1 Control-panel messages (continued)

Control panel message	Description	Recommended action
Authentication Required	Authentication has been enabled for this feature or destination. A username and password are required.	Type the user name and password, or contact the network administrator.
Authentication Required To Use This Feature	A user name and password are required.	Type the user name and password, or contact the network administrator.
Check the glass and remove any paper To continue press Start	A digital send or copy job has been performed from the scanner glass, but the original document needs to be removed.	Remove the original document from the scanner glass, and then press Start .
Close flatbed cover during initialization	The scanner cannot initialize while the scanner cover is open.	Close the scanner cover.
Digital send communication error	An error has occurred during a digital send task.	Contact the network administrator.
Document feeder bin full	The document feeder (ADF) output bin is full.	Remove all media from the document feeder (ADF) output bin.
Document feeder cover open	The document feeder (ADF) cover is open.	Close the document feeder (ADF) cover. Follow the instructions in the onscreen dialog box.
Document feeder empty	The document feeder (ADF) does not contain paper.	Load paper in the document feeder (ADF) input tray.
Document feeder paper jam	Media is jammed in the document feeder (ADF).	Follow the instructions in the onscreen dialog box. See Clear jams on page 75 .
Document feeder pick error	The document feeder (ADF) experienced an error while picking media.	Make sure that your original contains no more than 50 pages. Follow the instructions in the onscreen dialog box.
Flatbed Cover Open	The device scanner cover is open.	Close the scanner cover.
Folder list is full. To add a folder, you must first delete a folder.	The device limits the number of folders that can be established.	Delete an unused folder to add a new folder.
Front side optical system error	The scanner has experienced an error.	To temporarily clear the message so you can send a fax or send e-mail, touch Hide . If this message persists, contact an HP-authorized service or support provider. See the HP support flyer or go to www.hp.com/support/9250c .
HP digital sending: delivery error	A digital send job has failed and cannot be delivered.	Send the job again.
Jam in document feeder	Media is jammed in the document feeder (ADF).	Remove jammed media from the document feeder (ADF). Follow the instructions in the onscreen dialog box, or see Clear jams on page 75 . If the message persists after all jams have been cleared, a sensor might be stuck or broken. Contact an HP-authorized service or support provider. See the HP support flyer, or go to www.hp.com/support/9250c .
LDAP server is not responding. Contact administrator.	The LDAP server has exceeded the time out value for an address request.	Verify the LDAP server address. See Solve e-mail problems on page 77 . Contact the network administrator.

Table 6-1 Control-panel messages (continued)

Control panel message	Description	Recommended action
Network connection required for digital sending. Contact administrator.	A digital-sending feature has been configured, but a network connection is not detected.	Verify the network connection. Contact the network administrator.
Novell Login Required	Novell authentication has been enabled for this destination.	Enter Novell network credentials to access the copy and fax features.
Password or name is incorrect. Please enter correct login.	The user name or password was typed incorrectly.	Retype the user name and password.
Scan failure Press Start to rescan	The scan was unsuccessful and the document needs to be rescanned.	If necessary, reposition the document to rescan it, and then press Start .
SMTP gateway not responding	The SMTP gateway has exceeded a time out value.	Verify the e-mail server address. See Solve e-mail problems on page 77 . Contact the network administrator.
The folder you have entered is not a valid folder.	The folder name was entered incorrectly, or the folder does not exist.	Re-enter the folder name correctly, or add the folder.
Unable to connect	A network connection is not detected.	Verify the network connection. Contact the network administrator.
Unable to send	A network connection is not detected.	Verify the network connection. Contact the network administrator.
Unable to send fax. Please check fax configuration.	The device is unable to send a fax job.	Contact the network administrator.
User name or password is incorrect. Please re-enter.	The user name or password was typed incorrectly.	Retype the user name and password.

Jams

Avoid jams

Use the following information to avoid jams when using the ADF.

- When loading paper into the ADF, ensure that the paper stack is square and straight and the paper guides are adjusted to the width of the page to be scanned
- Do not overload the ADF. The ADF was designed to hold 50 sheets of 75 g/m² (20 lb) bond paper.
- If the paper to be scanned using the ADF was previously folded, flatten it to the best of your ability. Try to remove all wrinkles and folds from the paper.
- If the paper to be scanned using the ADF was previously stapled, it might be necessary to “fan” the corner of the page where the staple was inserted. Often, the hole that the staple created makes the pages stick together (that is, interlocks the pages).
- Remove any stick-on notes or labels that are affixed to the pages being scanned. If the labels have deposited excessive residual adhesive to the paper, you might have to clean it off the paper before it is sent through the ADF.
- Paper that has been three-hole punched, been removed from a wire-comb or plastic comb binding, or has perforations might be difficult to send through the ADF.
- If the leading edge of the page to be scanned is excessively worn or frayed, try rotating the paper before scanning.
- Paper can acclimatize to the environment around it. If the operating environment is excessively dry, the paper might become dry and subject to static electricity. Excessively dry sheets of paper tend to stick together, which might lead to difficulty when feeding through the ADF.

Clear jams

Follow these instructions to clear paper jams in the digital-sender ADF.

1. Press the release button to open the ADF cover.

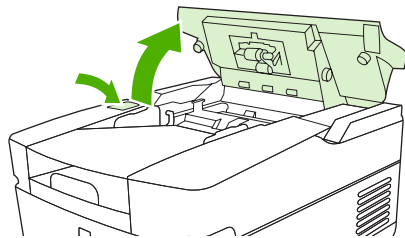

2. Remove any jammed media from this area.
3. Make sure that you have removed all of the pieces of torn media.

4. Close the ADF cover.

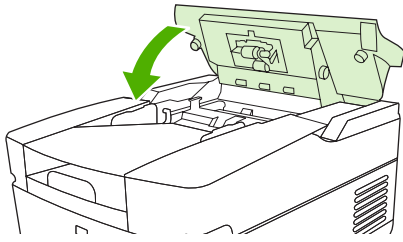

Solve e-mail problems

If you are unable to send e-mails by using the digital-send feature, you might need to reconfigure the SMTP gateway address or the LDAP gateway address. Open the configuration page to find the current SMTP and LDAP gateway addresses. See [Use information pages on page 52](#). Use the following procedures to check if the SMTP and LDAP gateway addresses are valid.

Validate the e-mail server (SMTP gateway) address



NOTE: This procedure is for Windows operating systems.

1. Open an MS-DOS command prompt: click **Start**, click **Run**, and then type `cmd`.
2. Type `telnet` followed by the SMTP gateway address and then the number **25**, which is the port over which the MFP is communicating. For example, type `telnet 123.123.123.123 25` where "123.123.123.123" represents the SMTP gateway address.
3. Press **Enter**. If the SMTP gateway address is *not* valid, the response contains the message `Could not open connection to the host on port 25: Connect Failed`.
4. If the SMTP gateway address is not valid, contact the network administrator.

Validate the LDAP gateway address



NOTE: This procedure is for Windows operating systems.

1. Open Windows Explorer. In the address bar, type `LDAP://` immediately followed by the LDAP gateway address. For example, type `LDAP://12.12.12.12` where "12.12.12.12" represents the LDAP gateway address.
2. Press **Enter**. If the LDAP gateway address is valid, the **Find People** dialog box opens.
3. If the LDAP gateway address is not valid, contact the network administrator.

A Service and support

Hewlett-Packard limited warranty statement

HP PRODUCT	DURATION OF LIMITED WARRANTY
HP 9250C Digital Sender	One-year on-site warranty

HP warrants to you, the end-user customer, that HP hardware and accessories will be free from defects in materials and workmanship after the date of purchase, for the period specified above. If HP receives notice of such defects during the warranty period, HP will, at its option, either repair or replace products which prove to be defective. Replacement products may be either new or equivalent in performance to new.

HP warrants to you that HP software will not fail to execute its programming instructions after the date of purchase, for the period specified above, due to defects in material and workmanship when properly installed and used. If HP receives notice of such defects during the warranty period, HP will replace software which does not execute its programming instructions due to such defects.

HP does not warrant that the operation of HP products will be uninterrupted or error free. If HP is unable, within a reasonable time, to repair or replace any product to a condition as warranted, you will be entitled to a refund of the purchase price upon prompt return of the product.

HP products may contain remanufactured parts equivalent to new in performance or may have been subject to incidental use.

Warranty does not apply to defects resulting from (a) improper or inadequate maintenance or calibration, (b) software, interfacing, parts or supplies not supplied by HP, (c) unauthorized modification or misuse, (d) operation outside of the published environmental specifications for the product, or (e) improper site preparation or maintenance.

TO THE EXTENT ALLOWED BY LOCAL LAW, THE ABOVE WARRANTIES ARE EXCLUSIVE AND NO OTHER WARRANTY OR CONDITION, WHETHER WRITTEN OR ORAL, IS EXPRESSED OR IMPLIED AND HP SPECIFICALLY DISCLAIMS ANY IMPLIED WARRANTIES OR CONDITIONS OF MERCHANTABILITY, SATISFACTORY QUALITY, AND FITNESS FOR A PARTICULAR PURPOSE. Some countries/regions, states or provinces do not allow limitations on the duration of an implied warranty, so the above limitation or exclusion might not apply to you. This warranty gives you specific legal rights and you might also have other rights that vary from country/region to country/region, state to state, or province to province. HP's limited warranty is valid in any country/region or locality where HP has a support presence for this product and where HP has marketed this product. The level of warranty service you receive may vary according to local standards. HP will not alter form, fit or function of the product to make it operate in a country/region for which it was never intended to function for legal or regulatory reasons.

TO THE EXTENT ALLOWED BY LOCAL LAW, THE REMEDIES IN THIS WARRANTY STATEMENT ARE YOUR SOLE AND EXCLUSIVE REMEDIES. EXCEPT AS INDICATED ABOVE, IN NO EVENT WILL HP OR ITS SUPPLIERS BE LIABLE FOR LOSS OF DATA OR FOR DIRECT, SPECIAL, INCIDENTAL, CONSEQUENTIAL

(INCLUDING LOST PROFIT OR DATA), OR OTHER DAMAGE, WHETHER BASED IN CONTRACT, TORT, OR OTHERWISE. Some countries/regions, states or provinces do not allow the exclusion or limitation of incidental or consequential damages, so the above limitation or exclusion may not apply to you.

THE WARRANTY TERMS CONTAINED IN THIS STATEMENT, EXCEPT TO THE EXTENT LAWFULLY PERMITTED, DO NOT EXCLUDE, RESTRICT OR MODIFY AND ARE IN ADDITION TO THE MANDATORY STATUTORY RIGHTS APPLICABLE TO THE SALE OF THIS PRODUCT TO YOU.

Customer self repair warranty service

HP products are designed with many Customer Self Repair (CSR) parts to minimize repair time and allow for greater flexibility in performing defective parts replacement. If during the diagnosis period, HP identifies that the repair can be accomplished by the use of a CSR part, HP will ship that part directly to you for replacement. There are two categories of CSR parts: 1) Parts for which customer self repair is mandatory. If you request HP to replace these parts, you will be charged for the travel and labor costs of this service. 2) Parts for which customer self repair is optional. These parts are also designed for Customer Self Repair. If, however, you require that HP replace them for you, this may be done at no additional charge under the type of warranty service designated for your product.

Based on availability and where geography permits, CSR parts will be shipped for next business day delivery. Same-day or four-hour delivery may be offered at an additional charge where geography permits. If assistance is required, you can call the HP Technical Support Center and a technician will help you over the phone. HP specifies in the materials shipped with a replacement CSR part whether a defective part must be returned to HP. In cases where it is required to return the defective part to HP, you must ship the defective part back to HP within a defined period of time, normally five (5) business days. The defective part must be returned with the associated documentation in the provided shipping material. Failure to return the defective part may result in HP billing you for the replacement. With a customer self repair, HP will pay all shipping and part return costs and determine the courier/carrier to be used.

Hewlett-Packard limited warranty statement for software

HP PRODUCT	DURATION OF WARRANTY
HP MFP DIGITAL SENDING SOFTWARE v. 4	90 days

1. HP warrants to you that the HP SOFTWARE PRODUCT will not fail to execute its programming instructions for 90 days after the date of purchase due to defects in material and workmanship when properly installed and used. If HP receives notice of such defects during the warranty period, HP will replace SOFTWARE PRODUCT media, which does not execute its programming instructions due to such defects.
2. HP does not warrant that the operation of HP products will be uninterrupted or error free. If HP is unable, within a reasonable time, to replace the SOFTWARE PRODUCT to a condition as warranted, HP may request that you uninstall the SOFTWARE PRODUCT and return it to HP for a refund.
3. ANY IMPLIED WARRANTY OF MERCHANTABILITY OR FITNESS FOR A PARTICULAR PURPOSE IS LIMITED TO THE DURATION OF THE EXPRESS WARRANTY SET FORTH ABOVE. Some states or provinces do not allow limitations on the duration of an implied warranty, so the above limitation or exclusion might not apply to you. This warranty gives you specific legal rights and you might also have other rights that vary from state to state, or province to province.
4. THE REMEDIES IN THIS WARRANTY STATEMENT ARE YOUR SOLE AND EXCLUSIVE REMEDIES. EXCEPT AS INDICATED ABOVE, IN NO EVENT WILL HP BE LIABLE FOR LOSS OF DATA OR FOR DIRECT, SPECIAL, INCIDENTAL, CONSEQUENTIAL (INCLUDING LOST PROFIT), OR OTHER DAMAGE, WHETHER BASED IN CONTRACT, TORT, OR OTHERWISE. Some states or provinces do not allow the exclusion or limitation of incidental or consequential damages, so the above limitation or exclusion may not apply to you.

Note: The limited warranty for this product and accompanying software is located in the product documentation that you received with this product. Please review it at this time.

ATTENTION: USE OF THE SOFTWARE IS SUBJECT TO THE HP SOFTWARE LICENSE TERMS SET FORTH BELOW. USING THE SOFTWARE INDICATES YOUR ACCEPTANCE OF THESE LICENSE TERMS. IF YOU DO NOT ACCEPT THESE LICENSE TERMS, YOU MUST RETURN THE SOFTWARE FOR A FULL REFUND. IF THE SOFTWARE IS SUPPLIED WITH ANOTHER PRODUCT, YOU MAY RETURN THE ENTIRE UNUSED PRODUCT FOR A FULL REFUND.

Availability of support and service

Around the world, HP provides a variety of service and support options for purchase. Availability of these programs will vary depending upon your location.

HP maintenance agreements

HP has several types of maintenance agreements that meet a wide range of support needs. Maintenance agreements are not part of the standard warranty. Support services vary by location. Contact HP Customer Care to determine the services available to you and for more information about maintenance agreements. In general, the digital sender will have the following maintenance agreement:

Next-Day Onsite Service

This agreement provides support by the next working day following a service request. Extended coverage hours and extended travel beyond HP's designated service zones are available on most on-site agreements (for additional charges).

B Specifications

- [Physical specifications](#)
- [Electrical specifications](#)
- [Power consumption specifications](#)
- [Environmental specifications](#)
- [Acoustic emissions](#)

Physical specifications

Table B-1 Physical specifications (without keyboard extended)

Height	Depth	Width	Weight
340.26 mm (13.40 inches)	571.82 mm (22.51 inches)	452.62 mm (17.82 inches)	23.09 kg (50 lbs)

Electrical specifications

Table B-2 Electrical specifications

Power requirements	100-240V (±10%) 50/60 Hz (±2 Hz)
Minimum recommended circuit capacity	1.0 Amp



WARNING! Power requirements are based on the country/region where the device is sold. Do not convert operating voltages. This will damage the digital sender and void the product warranty.

Power consumption specifications

Table B-3 Power consumption (average, in watts)¹

Scanning (55 ipm) ²	Ready	Sleep	Off
98 W	35 W	15.7 W	0 W

¹ Values subject to change. See www.hp.com/support/9250c for current information.

² Power reported is highest value measured for color and monochrome scanning using all standard voltages.

³ Default time from Ready mode to Sleep = 60 minutes.

⁴ Heat dissipation in Ready mode = 123 BTU/Hour.

Environmental specifications

Table B-4 Environmental specifications¹

	Recommended	Operating	Storage
Temperature	20° to 27°C (68° to 81°F)	0° to 40°C (32° to 104°F)	-30° to 60°C (-22° to 140°F)
Relative humidity	15% to 80%	15% to 80%	15% to 85%

¹ Values are subject to change. See www.hp.com/support/9250c for current information.



CAUTION: The operating environment should be stable, with no abrupt changes in temperature or humidity that might damage the device. If you move the device from a cold environment to a warm one, wait about two hours before using it.

Acoustic emissions

Table B-5 Acoustic emissions

Sound Power Level	Declared per ISO 9296 ¹
Scanning ²	$L_{WA_d} = 6.8$ Bels (A) [68 dB (A)]
Ready	$L_{WA_d} = 4.9$ Bels (A) [49 dB (A)]
Sound Pressure Level - Bystander Position	Declared per ISO 9296 ¹
Scanning ²	$L_{pAm} = 53$ dB(A)
Ready	$L_{pAm} = 35$ dB(A)

¹ Values are subject to change. See www.hp.com/support/9250c for current information.

² Configuration tested: Scanning simplex monochrome using ADF at 55 ppm and letter paper.

C Regulatory information

- [FCC regulations](#)
- [Environmental Product Stewardship program](#)
- [Declaration of conformity](#)
- [Country-/region-specific safety statements](#)

FCC regulations

This equipment has been tested and found to comply with the limits for a Class B digital device, pursuant to Part 15 of the FCC rules. These limits are designed to provide reasonable protection against harmful interference in a residential installation. This equipment generates, uses, and can radiate radio frequency energy. If this equipment is not installed and used in accordance with the instructions, it may cause harmful interference to radio communications. However, there is no guarantee that interference will not occur in a particular installation. If this equipment does cause harmful interference to radio or television reception, which can be determined by turning the equipment off and on, the user is encouraged to try to correct the interference by one or more of the following measures:

- Reorient or relocate the receiving antenna.
- Increase separation between equipment and receiver.
- Connect equipment to an outlet on a circuit different from that to which the receiver is located.
- Consult your dealer or an experienced radio/TV technician.



NOTE: Any changes or modifications to the device that are not expressly approved by HP could void the user's authority to operate this equipment.

Use of a shielded interface cable is required to comply with the Class B limits of Part 15 of FCC rules.

Environmental Product Stewardship program

Protecting the environment

Hewlett-Packard Company is committed to providing quality products in an environmentally sound manner. This product has been designed with several attributes to minimize impacts on our environment.

Ozone production

This product generates no appreciable ozone gas (O₃).

Power consumption

Power usage drops significantly while in Sleep mode, which saves natural resources and saves money without affecting the high performance of this product.

Plastics

Plastic parts over 25 grams are marked according to international standards that enhance the ability to identify plastics for recycling purposes at the end of the product's life.

Material restrictions

This HP product does not contain added mercury.

This HP product contains a battery that might require special handling at end-of-life. The batteries contained in or supplied by Hewlett-Packard for this product include the following:

HP 9250C Digital Sender device	
Type	Carbon monofluoride lithium battery BR1632
Weight	1.5 g
Location	On formatter board
User-removable	No





廢電池請回收

For recycling information, you can go to www.hp.com/recycle, or contact your local authorities or the Electronics Industries Alliance: www.eiae.org.

Disposal of waste equipment by users in private households in the European Union

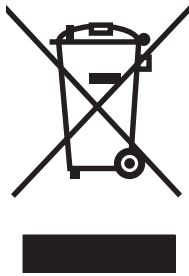

This symbol on the product or on its packaging indicates that this product must not be disposed of with your other household waste. Instead, it is your responsibility to dispose of your waste equipment by handing it over to a designated collection point for the recycling of waste electrical and electronic equipment. The separate collection and recycling of your waste equipment at the time of disposal will help to conserve natural resources and ensure that it is recycled in a manner that protects human health and the environment. For more information about where you can drop off your waste equipment for recycling, please contact your local city office, your household waste disposal service or the shop where you purchased the product.

Material Safety Data Sheet (MSDS)

Material Safety Data Sheets (MSDS) for supplies containing chemical substances (for example, toner) can be obtained by contacting the HP Web site at www.hp.com/go/msds or www.hp.com/hpinfo/community/environment/productinfo/safety.

For more information

To obtain information about these environmental topics:

- Product environmental profile sheet for this and many related HP products
- HP's commitment to the environment
- HP's environmental management system
- HP's end-of-life product return and recycling program
- Material Safety Data Sheets

Visit www.hp.com/go/environment or www.hp.com/hpinfo/globalcitizenship/environment.

Declaration of conformity

Declaration of Conformity

according to ISO/IEC Guide 22 and EN 45014

Manufacturer's Name: Hewlett-Packard Singapore Pte Ltd
Manufacturer's Address: Imaging and Printing Manufacturing Operations,
60 Alexandra Terrace, #07-01, The Comtech, Singapore, 118502

declares, that the product

Product Name: HP Digital Sender 9250C
Regulatory Model³⁾: BOISB-0401-00
Product Options: ALL

conforms to the following Product Specifications:

Safety: IEC 60950-1:2001 / EN60950-1: 2001
IEC 60825-1:1994 + A1:2002 + A2:2001 / EN 60825-1:1994 + A1:2002 + A2:2001 (Class 1 Laser/LED Product)
GB4943-2001

EMC: CISPR 22:1997 / EN 55022:1998 Class B¹⁾
EN 61000-3-2:2000
EN 61000-3-3:1995 + A1
EN 55024:1998 +A1 + A2
FCC Title 47 CFR, Part 15 Class B²⁾, ICES-003, Issue 4
GB9254-1998, GB17625.1-1998

Supplementary Information:

The product herewith complies with the requirements of the EMC Directive 89/336/EEC and the Low Voltage Directive 73/23/EEC, and carries the CE-Marking accordingly.

- 1) The product was tested in a typical configuration with Hewlett-Packard Personal Computer Systems.
- 2) This Device complies with Part 15 of the FCC Rules. Operation is subject to the following two conditions: (1) this device may not cause harmful interference, and (2) this device must accept any interference received, including interference that may cause undesired operation.
- 3) For regulatory purposes, this product is assigned a Regulatory model number. This number should not be confused with the marketing name or the product number(s).

, , Singapore

July 27, 2006

For regulatory topics only:

Australia Contact: Product Regulations Manager, Hewlett-Packard Australia Ltd.,, 31-41 Joseph Street, Blackburn, Victoria 3130, Australia
European Contact: Your Local Hewlett-Packard Sales and Service Office or Hewlett-Packard GmbH, Department HQ-TRE / Standards Europe,, Herrenberger Strasse 140, , D-71034, Böblingen, (FAX: +49-7031-14-3143)
USA Contact: Product Regulations Manager, Hewlett-Packard Company,, PO Box 15, Mail Stop 160, Boise, Idaho 83707-0015, , (Phone: 208-396-6000)

Country-/region-specific safety statements

Canadian DOC regulations

Complies with Canadian EMC Class B requirements.

« Conforme à la classe B des normes canadiennes de compatibilité électromagnétique. « CEM ». »

VCCI statement (Japan)

この装置は、情報処理装置等電波障害自主規制協議会（VCCI）の基準に基づくクラスB情報技術装置です。この装置は、家庭環境で使用することを目的としていますが、この装置がラジオやテレビジョン受信機に近接して使用されると、受信障害を引き起こすことがあります。
取扱説明書に従って正しい取り扱いをして下さい。

EMI statement (Korea)

B급 기기 (가정용 정보통신기기)

이 기기는 가정용으로 전자파적합등록을 한 기기로서
주거지역에서는 물론 모든지역에서 사용할 수 있습니다.

Index

A

access denied message 72
acoustic emissions 87
address book, e-mail
 deleting addresses 47
address books, e-mail
 adding addresses 47
 clearing 30
 recipient lists 46
 recipient lists, creating 46
address books, e-mail
 auto-complete function 46
 LDAP server errors 73
 LDAP support 43
ADF
 error messages 73
 jams, preventing 75
 loading 38
 locating 8
 maintenance kit, replacing 58
 mylar sheet, replacing 58
 paper specifications 7
 speed 4
Administration menu, control panel 15
administrator privileges 2
agreements, maintenance 84
Attention light
 locating 12

B

batteries included 91
bins, ADF 8
buttons, control panel
 locating 12
 touchscreen 14

C

calibrating scanner 30, 68
Canadian DOC regulations 94

cleaning
 exterior 60
clock
 error message 71
configuration page
 Information menu 15
 viewing 52
contracts, maintenance 84
control panel
 access denied 72
 Administration menu 15
 buttons 12
 E-mail Setup menu 28
 e-mail screen 45
 help 14
 Home screen 13
 Information menu 15
 Initial Setup menu 21
 lights 12
 locating 8
 Management menu 20
 messages, alphabetical list 71
 messages, numerical list 71
 messages, types of 71
 Resets menu 30
 security 57
 Send Setup menu 28
 Service menu 30
 Time/Scheduling menu 19
 touchscreen buttons 14

copying
 ADF, loading 38
customer support
 embedded Web server links 55

D

Data light
 locating 12
date, setting 19

declaration of conformity 93
default settings
 Resets menu 30
diagnostics
 networks 23
digital faxing 50
digital sending
 address books 46, 47
 configuring e-mail 43
 control-panel settings 45
 error messages 73, 74
 folders 48
 gateways, finding 44
 job settings 41
 LDAP support 43
 recipient lists 46
 sending documents 45
 server settings 43
 Setup menu 28
 SMTP support 43
 validating gateway addresses 77
 workflow 49
Digital Sending tab, embedded Web server 55
disposal, end-of-life 91
downloading firmware 64
duty cycle 4

E

e-mail
 address books 46
 sending documents 45
E-mail Setup menu 28
EIO cards
 errors 72
electrical specifications 86
embedded Web server 53
end-of-life disposal 91
environment specifications 87

- Error button, control panel touchscreen 14
- error messages
 - alphabetical list 71
 - numerical list 71
 - types of 71
- European Union, waste disposal 92
- extended warranty 84
- e-mail
 - address books 47
 - auto-complete function 46
 - configuring 43
 - control-panel settings 45
 - error messages 73, 74
 - gateways, finding 44
 - job settings 41
 - LDAP errors 73
 - LDAP support 43
 - recipient lists 46
 - security 57
 - sending documents 45
 - server settings 43
 - SMTP support 43
 - validating gateway addresses 77
- F**
 - fax accessory
 - ADF, loading 38
 - faxing, digital 50
 - features 3
 - firmware, upgrading 64
 - folders
 - error messages 73
 - sending to 48
 - front side optical system errors 73
 - FTP
 - firmware updates 64
 - FTP, sending to 49
- G**
 - gateways
 - configuring 43
 - finding 44
 - testing 44
 - validating addresses 77
 - glass
 - scanning from 38
 - graphical display, control panel 12
- H**
 - Help button, control panel touchscreen 14
 - help, control panel 14
 - Home button, control panel touchscreen 14
 - Home screen, control panel 13
 - HP Jetdirect firmware upgrades 67
 - HP Jetdirect Inside 3
 - HP Jetdirect print server
 - configuring 35
 - error messages 72
 - settings 21
 - HP Web Jetadmin 56, 66
 - humidity specifications 87
- I**
 - I/O configuration
 - network configuration 33
 - settings 21
 - Information menu 15
 - information pages 52
 - Information tab, embedded Web server 54
 - Initial Setup menu 21
 - interface ports 8
 - internal clock errors 71
 - Internet fax 50
 - IP address
 - server settings 43
- J**
 - jams
 - preventing 75
 - release button, locating 8
 - Japanese VCCI statement 94
 - Jetadmin, HP Web 56, 66
 - Jetdirect firmware upgrades 67
 - Jetdirect Inside 3
 - Jetdirect print server
 - configuring 35
 - error messages 72
 - settings 21
- K**
 - keys, control panel
 - locating 12
 - touchscreen 14
 - Korean EMI statement 94
- L**
 - LAN fax 50
 - LDAP servers
 - connecting to 43
 - error messages 73
 - validating gateway addresses 77
 - LEDs, control panel troubleshooting 70
 - lights
 - control panel 12
 - lights, control panel
 - troubleshooting 70
 - link speed settings 26
 - loading
 - ADF 38
 - scanner glass 38
 - lock, device 57
 - lock, scanner 8
 - logging in 41
- M**
 - maintenance agreements 84
 - maintenance kit, ADF
 - replacing 58
 - Management menu 20
 - material restrictions 91
 - Material Safety Data Sheet (MSDS) 92
 - media
 - jam release button, locating 8
 - media jams
 - preventing 75
 - media specifications 7
 - memory
 - included 3
 - menus, control panel
 - access denied 72
 - Administration 15
 - E-mail Setup 28
 - Information 15
 - Initial Setup 21
 - Management 20
 - Resets 30

- Send Setup 28
- Service 30
- Time/Scheduling 19
- mercury-free product 91
- messages
 - alphabetical list 71
 - numerical list 71
 - types of 71
- mylar sheet, replacing 58

N

- Network Folder, scan to 48
- Networking tab, embedded Web server 55
- networks
 - administrator privileges 2
 - configuring 33
 - configuring gateway addresses 43
 - default gateway 34
 - diagnostics 23
 - finding SMTP gateways 44
 - HP Jetdirect Inside 3
 - HP Jetdirect print server error messages 72
 - HP Web Jetadmin 56
 - IP address 33
 - link speed settings 26
 - requirements 6
 - SMTP servers 43
 - subnet mask 34
 - TCP/IP parameters 33
 - TCP/IP settings 21
 - testing SMTP settings 44
 - validating gateway addresses 77
- Next-Day Onsite Service 84
- noise specifications 87
- Novell login required 74
- Novell NetWare support 32

O

- on/off switch 8
- online help, control panel 14
- onsite service 84
- operating environment specifications 87
- operating system requirements 6

- ordering
 - supplies through embedded Web server 55
- output bins, ADF 8

P

- pages per minute 4
- paper
 - jam release button, locating 8
- paper jams
 - preventing 75
- paper specifications 7
- passwords 57
- physical specifications 10, 86
- ports 8
- power specifications 86
- power switch 8
- privileges, administrator 2
- problem-solving
 - Error button, control panel touchscreen 14
 - gateway addresses 77
 - messages, types of 71
 - networks 23

R

- Ready light
 - locating 12
- recipient lists 46
- regulatory statements
 - declaration of conformity 93
- release button, jams 8
- remote firmware update (RFU) 64
- replacing
 - ADF Maintenance Kit 58
 - mylar sheet 58
- reset button 12
- Resets menu, control panel 30
- rollers, cleaning 61

S

- scanner 3
- scanner calibration 30, 68
- scanner errors 73
- scanner glass
 - scanning from 38
- scanner head lock 8
- scanning
 - ADF, loading 38

- job settings 41
- using scanner glass 38
- scanning e-mail
 - validating gateway addresses 77
- scanning to e-mail
 - address books 46
 - sending documents 45
- scanning to e-mail
 - address books 47
 - configuring 43
 - control-panel settings 45
 - error messages 73, 74
 - gateways, finding 44
 - LDAP support 43
 - recipient lists 46
 - sending documents 45
 - server settings 43
 - SMTP support 43
- scanning to folder 48
- scanning to workflow 49
- security
 - lock, device 57
 - software access 57
- Send Setup menu 28
- Send to Folder 48
- Send to Workflow 49
- sending to e-mail
 - address books 46
 - sending documents 45
- sending to e-mail
 - about 43
 - address books 47
 - error messages 73, 74
 - gateways, finding 44
 - job settings 41
 - LDAP support 43
 - recipient lists 46
 - sending documents 45
 - server settings 43
 - settings 45
 - SMTP support 43
 - validating gateway addresses 77
- serial number, locating 8
- service agreements 84
- Service menu, control panel 30
- Settings tab, embedded Web server 54
- Sleep button 12

- Sleep mode
 - settings 19, 20
 - SMTP gateways
 - error messages 74
 - SMTP servers
 - configuring gateway
 - address 43
 - connecting to 43
 - finding gateways 44
 - gateways, finding 44
 - settings 43
 - testing 44
 - validating gateway
 - addresses 77
 - software
 - restricting access 57
 - warranty 82
 - space requirements 10
 - specifications
 - acoustic emissions 87
 - duty cycle 4
 - electrical 86
 - environment 87
 - features 3
 - network requirements 6
 - paper 7
 - physical 86
 - space requirements 10
 - speed 4
 - speed specifications 4
 - Start button 12
 - Start button, control panel
 - touchscreen 14
 - status
 - embedded Web server 54
 - Home screen, control
 - panel 13
 - messages, types of 71
 - Status button 12
 - Stop button 12
 - Stop button, control panel
 - touchscreen 14
 - subnet mask 34
 - supplies
 - ordering through embedded
 - Web server 55
 - Resets menu 30
 - status, viewing with embedded
 - Web server 54
 - support
 - embedded Web server
 - links 55
 - system requirements 6
 - workflow, send to 49
- T**
- TCP/IP settings 21
 - technical support 84
 - temperature specifications 87
 - tests
 - networks 23
 - time, setting 19
 - Time/Scheduling menu, control
 - panel 19
 - timeout settings 21
 - touch screen
 - cleaning 60
 - troubleshooting
 - about 70
 - control panel messages,
 - numerical 71
 - error messages, alphabetical
 - list 71
 - jams 75
- U**
- upgrading firmware 64
 - usage page, viewing 52
- V**
- validating gateway
 - addresses 77
 - voltage specifications 86
- W**
- wake time, setting 19
 - Warning button, control panel
 - touchscreen 14
 - warranty
 - Customer self repair 81
 - extended 84
 - product 79
 - software 82
 - Web Jetadmin 66
 - Web sites
 - firmware, downloading 64
 - HP Web Jetadmin,
 - downloading 56
 - Material Safety Data Sheet
 - (MSDS) 92
 - Windows 2000 fax 50

© 2007 Hewlett-Packard Development Company, L.P.

www.hp.com



CB472-90949